

THE STUDY OF KARSTIC AQUIFERS BY GEODETIC MEASUREMENTS IN BUS DE LA GENZIANA STATION – CANSIGLIO PLATEAU (NORTHEASTERN ITALY)

RAZISKAVE KRAŠKIH VODONOSNIKOV Z GEODETSKIMI MERITVAMI NA POSTAJI BUS DE LA GENZIANA, PLANOTA CANSIGLIO (SEVEROVZHODNA ITALIJA)

Barbara GRILLO¹, Carla BRAITENBERG¹, Roberto DEVOTI² & Ildikò NAGY¹

Abstract

UDC 556.33(450-18)

Barbara Grillo, Carla Braitenberg, Roberto Devoti & Ildikò Nagy: The study of Karstic aquifers geodetic measurements in Bus de la Genziana station – Cansiglio plateau (northeastern Italy)

We propose an interdisciplinary study of karstic aquifers using tiltmeters and GPS observations. The study region is located in northeastern Italy, in the seismic area of the Cansiglio Plateau. The Zöllner type Marussi tiltmeters are installed in a natural cavity (Bus de la Genziana) that is part of an interesting karstic area of particular hydrogeologic importance. The Livenza river forms from a number of springs at the foothills of the karstic massif and flows through the Friuli-Veneto plain into the Adriatic Sea. Comparing the tiltmeter signal recorded at the Genziana station with the local pluviometrical series and the hydrometric series of the Livenza river, a clear correlation is recognized. Moreover, the data of a permanent GPS station located on the southern slopes of the Cansiglio Massif (CANV) show also a clear correspondence with the water runoff. Here we present the hydrologic induced deformations as observed by tiltmeter and GPS. After heavy rain events we record rapid deformations both by tiltmeters and GPS corresponding to the rainfall duration. In the following days a slow geodetic motion recovers the accumulated deformation with a distinctive pattern both in tilt and GPS data, which correlates with the runoff of the karstic aquifer. The purpose of this research is to open a new multidisciplinary frontier between geodetic and karstic systems studies to improve the knowledge of the underground fluid flow circulation in karstic areas. Furthermore a better characterization of the hydrologic effects on GPS and tilt observations will have the benefit that these signals can be corrected when the focus of the study is to recover the tectonic deformation.

Keywords: tilting, tiltmeter, geodetic measurements, GPS, karstic aquifer, hydrology, Cansiglio.

Izvleček

UDK 556.33(450-18)

Barbara Grillo, Carla Braitenberg, Roberto Devoti & Ildikò Nagy: Raziskave kraških vodonosnikov z geodetskimi meritvami na postaji Bus de la Genziana, Planota Cansiglio (severovzhodna Italija)

V članku predstavimo interdisciplinarno študijo kraških vodonosnikov z uporabo klinometra in GPS meritev. Študijsko območje je v severovzhodni Italiji, na potresnem območju planote Cansiglio. Gre za hidrogeološko pomembno kraško območje; v vznožju masiva je več kraških izvirov reke Livenze, ki teče preko Furlanske nižine v Jadransko morje. V članku primerjamo podatke Marussijevega klinometra iz jame Bus de la Genziana in meritev GPS s postaje na južnem pobočju masiva, s pluviometričnimi in hidrometričnimi meritvami na reki Livenzi. V članku predstavimo hidrološko pogojene deformacije masiva, ki smo jih zaznali z omenjenimi meritvami. Klinometrične in GPS meritve zaznajo hitro deformacijo masiva ob močnem deževju. Sledi relaksacija nakopičene deformacije, ki kaže značilne vzorce odvisne od odtoka vode iz vodonosnika. Opisane raziskave predstavljajo nov pristop k študiju kraških hidroloških sistemov na osnovi geodetskih meritev. Metoda obenem omogoča obravnavo napak GPS in klinometričnih meritev, ki so namenjene spremljanju tektonskih deformacij.

Ključne besede: nagibanje, klinometer, geodetske meritve, GPS, kraški vodonosnik, hidrologija, Cansiglio, Italija.

¹ Department of Geosciences, University of Trieste, Via Weiss, 1, I - 34100 Trieste, Italy, e-mail: barbara.grillo@phd.units.it, berg@units.it, inagy@units.it

² National Institute of Geophysics and Volcanology, Via di Vigna Murata, 605, 00143 Roma, Italy, e-mail: devoti@ingv.it

Received/Prejeto: 9.9.2010

INTRODUCTION

The Cansiglio Plateau is a karstic massif situated in the Veneto-Friuli pre-Alpine region in northeast Italy (Fig. 1a). It is bordered to the south by the Cansiglio low angle thrust, part of the complex thrust system of the eastern southern Alps. This region was struck by numerous earthquakes with magnitudes up to 6 during historical times, and the fault activity is evidenced by Late Quaternary deformations affecting landforms and deposits (Galadini *et al.* 2005). The presence of a thick quaternary cover poses a limit to classical geologic surveys; nevertheless speleological explorations contribute to collect useful subsurface structural data. The surface hydrography is reduced to a minimum, as it has been replaced by the underground water flow. The supply of the deep aquifer

is given by water infiltration of meteoric precipitation (about 1800 mm/year) into the underground of the Cansiglio Plateau by means of sink-holes, dolines and cavities of prevalent vertical development (Grillo 2007).

In the present work we integrate indirect methodologies with the geologic knowledge of the karstic massif in order to understand the local hydrogeology better. Since December 2005 a couple of tiltmeters are installed on the Cansiglio Plateau in the natural cave of the Bus de la Genziana (Fregona, Treviso) (Figs. 1b & 3). The monitoring station is at 25 m depth and has been set up for the study of slow crustal movements. It is part of a network of geodetic stations run by the Department of Geosciences, University of Trieste (Grotta Gigante, Trieste and Grotta Nuova of Villanova, Udine), and the National Institute of Oceanography and Sperimental Experimental Geophysics (GPS FREDNET network, Zuliani 2003).

This research proposes the use of geodetic observations for the study of karstic aquifers by a statistical analysis of the hydrologically induced deformation, the rainfall, and the spring discharge. We compare the different geodetic observations with pluviometrical data of the Cansiglio Plateau and hydrometrical data of the River Livenza. We think that these instruments, tiltmeters and GPS, can give a new contribution to the understanding of underground water circulation (Longuevergne *et al.* 2009; Weise *et al.* 1999).

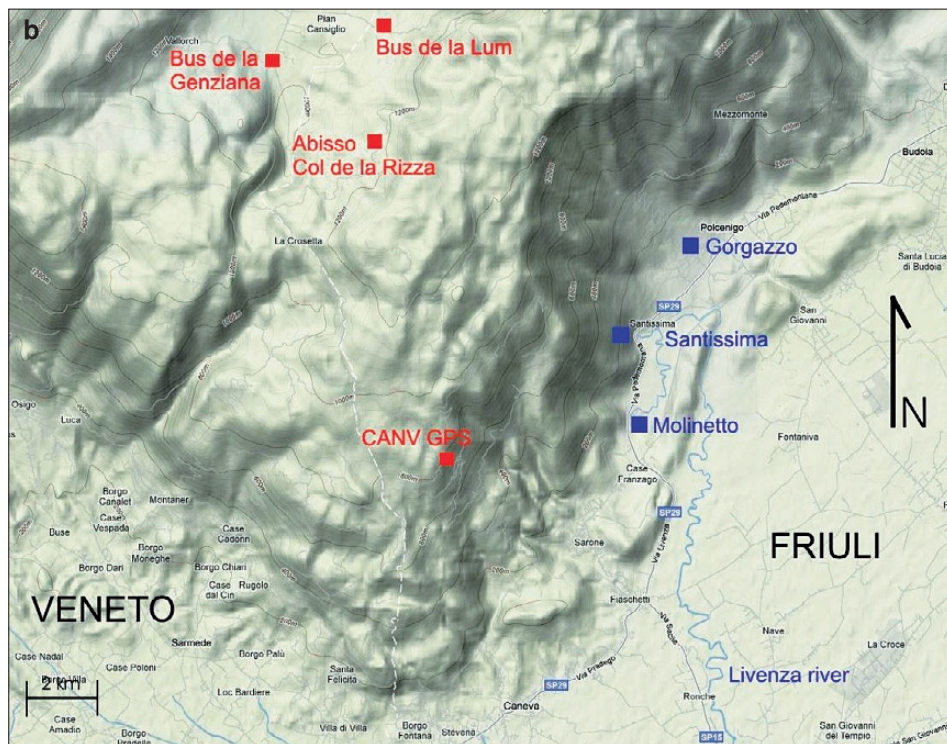
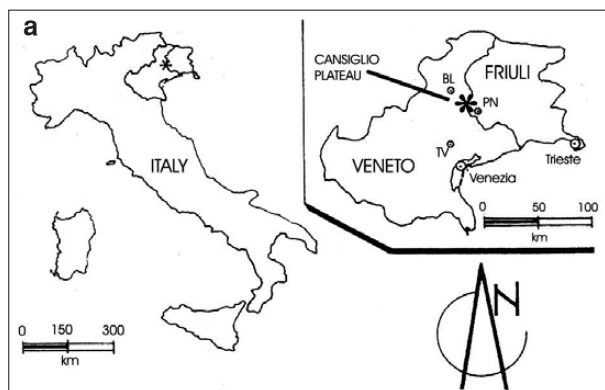

Fig. 1: a) location of Cansiglio - Cavallo Plateau; b) red squares represent the positions of the main caves of Plateau Cansiglio and the GPS station, blue squares the principal springs of the Livenza River.

GEOLOGICAL DESCRIPTION

The Cansiglio-Cavallo Plateau is a karstic massif situated in the Prealpi Carniche (Fig. 1b), which stretches forward as a mountainous block on the Venetian and Friulian plains and is divided between two regions, Veneto on the west and Friuli-Venezia-Giulia on the east; and three provinces Pordenone, Treviso and Belluno. Its maximum height above mean sea level is 2200 m, and it has two plateaus of medium height of 1000 m, the Cansiglio and the Piancavallo Plateau.

Since December 2005 the Cansiglio Plateau hosts a tiltmeter station in the Bus de la Genziana (Figs. 1b & 3), a Natural Hypogean Reserve managed by the Foresters Department of the State (Braitenberg *et al.* 2007). Notoriously, the zone is of medium-high seismic risk: in the recent history we recall the strong earthquake of 1936, which according to the magnitude scale used was quantified as having $M_s=5.8$ (Magnitude of surface wave) or $M_m=6.2$ (Macroseismic magnitude) (Pettenati and Sirovich, 2003). This underground station extends the network of tiltmeter stations of the Department of Geosciences, University of Trieste, already existing in Friuli, and in Trieste, westwards (Braitenberg and Zadro 1999; Braitenberg *et al.* 2005a, b). The station Grotta Nuova of Villanova in Tarcento of Udine (Braitenberg 1999a), the Grotta Gigante station, Trieste and the recent Bus de la Genziana station, are all set in interesting karstic areas. The River Livenza rises from the southeastern slope of the carbonatic Massif of Cansiglio - Cavallo. It is supplied by three main springs: the Gorgazzo, which has a recharge basin of 170 km², the Santissima of 500 km² and the Molinetto of 230 km². All three have an average flow from 5 to 10 cubic meters per second and derive from the thrust along the Caneva - Maniago Fault (Figs. 1b & 2).

The geologic formations concerning the Massif of Cansiglio have an age between the Noric (Upper Triassic) and the end of Miocene (Tertiary). For the zone of Cansiglio the stratigraphy proposed and revised by Cancian and Ghetti (1989) was considered. The rocks rele-

vant to the karstic phenomenon are the Scaglia (marly limestone), the Limestone Formation of Monte Cavallo and Cellina.

The Massif is characterized by a markedly deep karst, having about 200 caves and variegated surface morphology. Though the annual mean precipitation is about 1800 mm, the Cansiglio Plateau for the time being is without superficial hydrography, but is acting like an endorheic basin with an articulated system of underground canalization. Essentially three noteworthy caves (Fig. 1b) are considered: the Bus de la Lum with depth of 185 m, the Bus de la Genziana with a maximum depth of 587 m and a development of 8 km, and the Abisso Col de

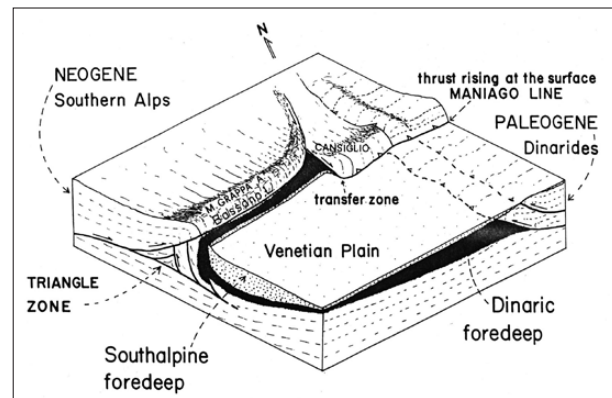

Fig. 2: Structural description of the Cansiglio - Cavallo Massif by Dogliani (1990).

la Rizza, the deepest cavity of all the mountainous group, reaching 800 m below topographic surface. Morphologically all three caves have a complex tunnel system, including shafts, halls, canyons, meanders, and sometimes are also well concretionated. The hydrologic connection between the Cansiglio Plateau and two of the three main Friulian sources, the Santissima and Molinetto origins of the Livenza River, have been demonstrated by recent tracing examinations (Vincenzi *et al.* 2011 in press).

INSTRUMENTAL DETAILS OF TILTMETERS

The interpretation of geodetic data in terms of crustal deformation and stresses has to consider also all the environmental factors that could contribute to the recorded signals, such as: the barometric pressure, the influence of superficial and underground watercourses, soil moisture,

water in the vadose zone, the seasonal temperature variation, and snow.

The Genziana pendulums consist of a pair of Marussi tiltmeters (Braitenberg 1999a) 0.5 m tall inside a cast iron bell resting on three small flat platforms of compact

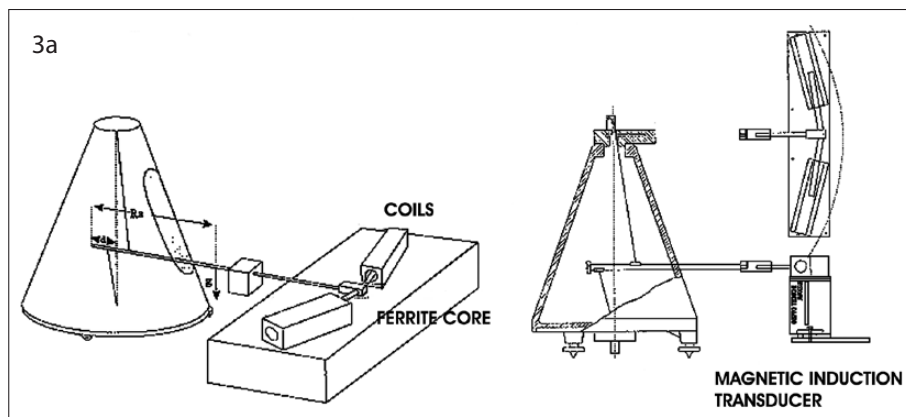

Fig. 3: a) Schematic design of the Marussi tiltmeter. The digital acquisition occurs by means of a magnetic induction transducer. b) The pair of tiltmeters in the Bus de la Genziana - Pian Caniglio, located 25 m below the surface (Photo: Barbara Grillo).



In Tab. 1 the principal instrumental characteristics are listed. The amplification factor is expressed as a function of the oscillation period of the pendulum in the horizontal and vertical plane. The amplification of the recorded signal depends on the distance between the observation point and the actual rotation axis of the horizontal pendulum. The resolution of the tiltmeter is near to 5 nrad, the value corresponding to the unit value of the digitizing process.

rock. The data acquisition is digital and based on an inductive transducer. These are horizontal pendulums with Zöllner type suspension (Zadro and Braitenberg 1999): the bar of the pendulum with the mass is suspended by two wires, an upper and a lower one (Fig. 3a, b), in such a way that the bar rotates in the horizontal plane. The rotation of the bar occurs around a virtual axis of rotation, which passes through the upper mounting point of the upper wire and the lower mounting point of the lower wire.

The inclination of the virtual rotation axis caused by crustal movements is recorded by the excursion of the pendulum arm with an angle several orders of magnitude greater than the inclination.

The inclinations are measured along two directions, NS and EW, recorded respectively by two pendulums installed in the station.

Tab. 1: Technical characteristics of Marussi tiltmeters.

Quantity	Value
Distance between upper and lower mountings	50 cm
Weight of housing case	45 kg
Total weight of the pendulum, including the wires	679 g
Distance of the centre of gravity from the rear suspension	32.0 cm
Distance of the actual axis of rotation from the rear suspension	3.9 cm
Moment of inertia with respect to the actual axis of rotation	5,500 g cm ²
Period of oscillation in the vertical plane, determined experimentally	1.3 sec
Period of oscillation in the horizontal plane	maintained at 90 sec plane

DISCUSSION OF TILTMETER OBSERVATIONS

The slow movement recorded by the tiltmeters is the sum of a tectonic deformation, a tidal deformation and the effect of environmental factors like temperature, superficial and underground water, and snow. The separation of the different signals is not always unequivocal. The tidal signal can be accurately modelled, the daily temperature has the exact solar day period, the hydrologic effects can be of all frequencies and can mask the tectonic signal. The first data of the Cansiglio station, starting in December 2005, constitute a period of technical testing and instrumental adjustment. The useful recordings for representing the tectonic movement start from 13th February 2006. Until now the direction of tectonic tilting keeps principally the southern direction (Fig. 4), even if this movement decreased during the year 2008. An exceptional case has been recorded on 3 September 2006, when the station sensed a sudden movement (duration less than 1 hour) in the direction SE, preceded by an accelerated southward movement in the previous 14 days, starting from 20 August. This signal could be attributed to a tectonic movement, which has occurred a seismically, without any significant seismic event occurring in the area. Altogether the movement was $4.75 \mu\text{rad}$ southwards and $2.75 \mu\text{rad}$ eastwards in the period between 20 August and 3 September 2006. Following this event the movement has continued in the southward direction until December 2008. From the beginning of 2009 it seems that the southward drift has stopped and the total yearly movement has been significantly reduced.

The yearly cycle of the other two stations, Grotta Gigante and Grotta Nuova of Villanova, completes a closed tilt signal, usually on an elliptical path (Braitenberg 1999b, c; Braitenberg *et al.* 2005a, b). In case of Bus de la Genziana only a seasonal semi-ellipse is recorded, and the southward tilting is preponderant on the cycle. During heavy rainfalls the tilt records become particularly disturbed and the deriving deformation can be interpreted as a hydrologic effect. Up to now we have not modelled the hydrologic effect by numerical methods, but the tilt signals exhibit a clear correlation with the rainfall events. Considering the time constants and the amplitude of the tilt signal, the contribution of the barometric effect is negligible in comparison to the hydrologic effect.

Comparing the tiltmeter time series with the pluviometric data of Cansiglio (station Tremedere ARPA Veneto) and with the hydrometric data of River Livenza (Civil Protection of Friuli Venezia Giulia Net of Hydrometric Monitoring), we noted a very clear causal relationship between the tilting and the runoff of underground rainwaters (Figs. 5 & 6).

Observing the tilt directions (Fig. 4) there are spikes or semi cycles with axis oriented NNW-SSE or NS, and assuming a hydrologic cause one can deduce that the direction of the runoff of waters is oriented in average along this direction. Sometimes different orientations are

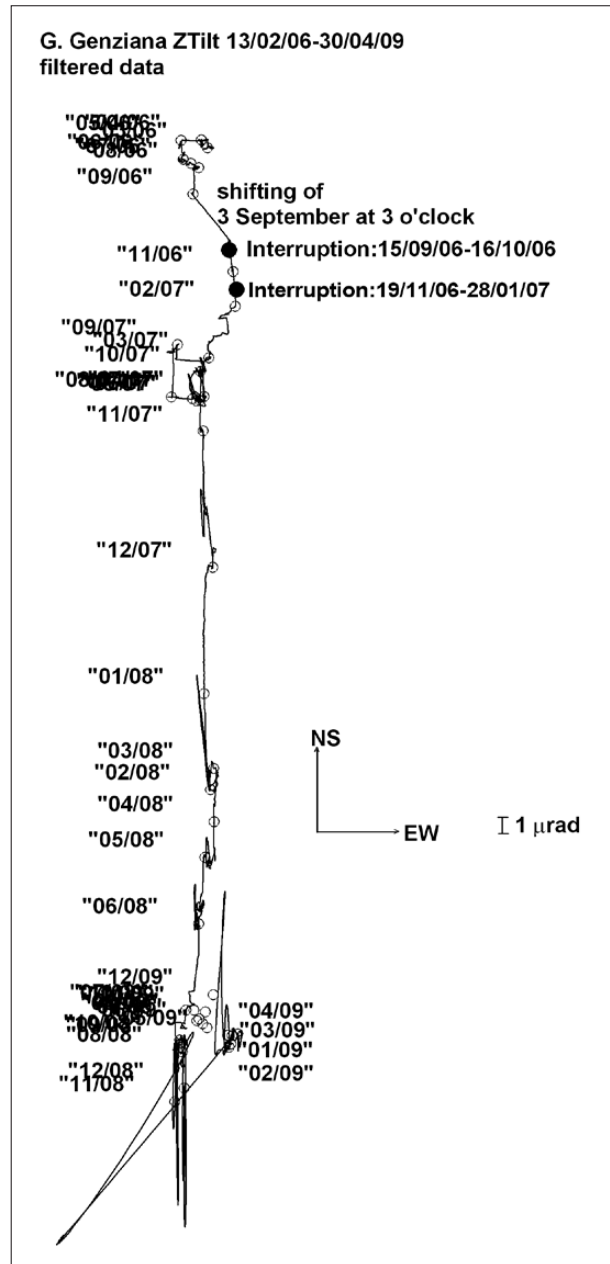

Fig. 4: Long term movement recorded by the tiltmeters in Bus de la Genziana: the tilting is southward directed from November 2006 until December 2008; meanwhile it is almost stationary from beginning of 2009. The almost linear fast movements are attributed to the underground runoff of rainwater near the cave, as will be shown in the remainder of this paper.

recorded and one can think that this variation is due to a non-homogeneous hydrology of the massif. Up to now a clear seasonal signature in the orientation changes is not evident. In December 2008 we observed a permanent eastward tilting correlated to a strong increase in the quantity of water (Fig. 5). The rainfall in autumn 2008 is significantly higher than in previous years (Figs. 4-6). The eastward shift of the EW tilt seems to be caused by a shift of the hydraulic loading moving towards the belt of the main springs of the massif.

Fig. 5 shows that generally the level of the River Livenza has an impulsive rise followed by an exponential decline. The rise is strictly connected to rainfalls. From

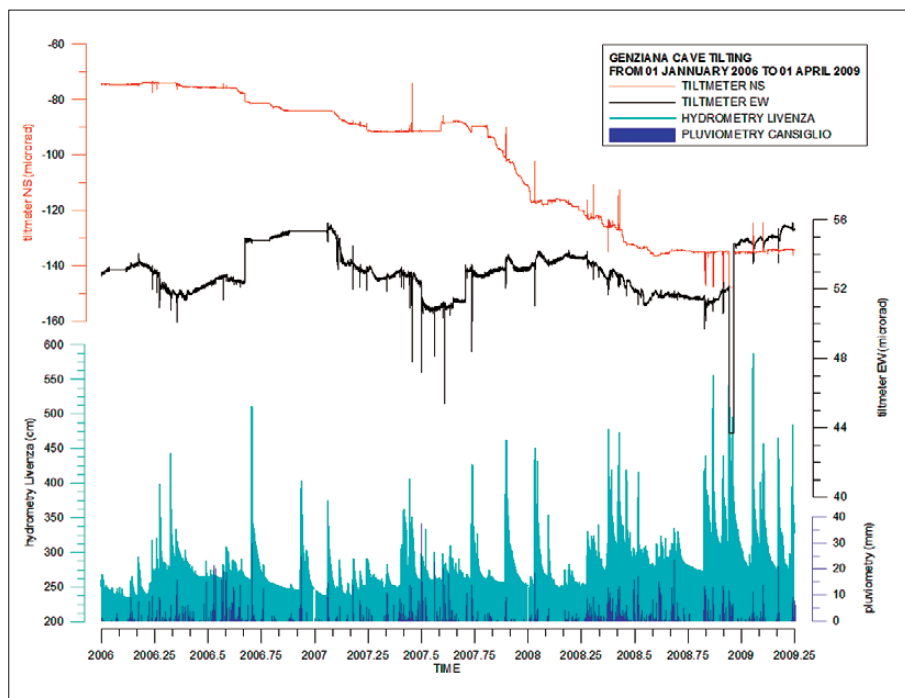

Fig. 5: The tilting signal of the two components compared with the hydrometry of Livenza and the rainfall of Cansiglio. Please notice the different scale factors used for representing the EW and NS components. We note a periodical variation in the component EW and a southward drift in the component NS, which could be of tectonic origin, due to the fact that the hydrology does not show an analogous drift. The hydrologic signal manifests itself as spikes and “loops” corresponding to rain events, and also as slow drift in correlation with the runoff curves of the aquifer.

the hydrologic point of view one can observe that the massif is loading quickly and slowly discharging (ARPA FVG 2006). The temporal characteristics of loading and discharging depend on the velocity of water movements, which depend on the dimensions of fractures and on the porosity of rocks. The two tiltmeter components show a long period signal, which is an almost yearly oscillation of the component EW, and a southward drift of the component NS. Moreover, quick westward movements are correlated with the impulsive rise of Livenza river. The

NS component shows impulsive movements oriented to the north or south, according to the period: during 2006 and at the end of 2008 in the direction south, whereas during 2007 and most of 2008 they are oriented in the direction north. The impulsive signals are perfectly correlated in the two components NS and EW.

In Fig. 6 two shorter time windows are represented. Here further characteristics of the hydrologic signal can be observed: the EW component has a rather complicated response to significant rain events (e.g. greater than 8-10 mm in one hour). The impulsive tilting, which starts typically a few hours following the rain event, happens first in the direction west, then inverts the direction towards

the east with the maximum excursion occurring with about two days of delay, and then expires. Considering the amplitude, the NS signal is generally greater than the EW signal. As an example (see Fig. 6a) in spring 2008 where the rainfall exceeded 18 mm in one hour, the EW tiltmeter signal is 3.25 μrad , and the NS signal is 14.54 μrad . The behaviour of the tiltmeters changes starting with the year 2009, as seen in Fig. 6b, which refers to the end of 2008 up to the beginning of 2009. The NS impulsive component switches now from tilting towards the south to an impulsive northward signal, whereas the EW component first alternates direction rapidly from east to west, then slowly goes back to the starting position.

Summarizing, the response of tiltmeters to a rain event is first immediate (a few hours) and then slow (a few days) in time, following the runoff curves of the aquifer. The recordings are extremely sensitive to atmospheric precipitation, and especially in the NS component, they cause a huge tilt amplitude. The tiltmeter nearly always recovers from the perturbation induced by the hydrologic effect.

The observed tiltmeter signal can be explained in terms of loading caused by runoff water flow in underground channels. A channel with high hydraulic permeability oriented approximately EW and located north of

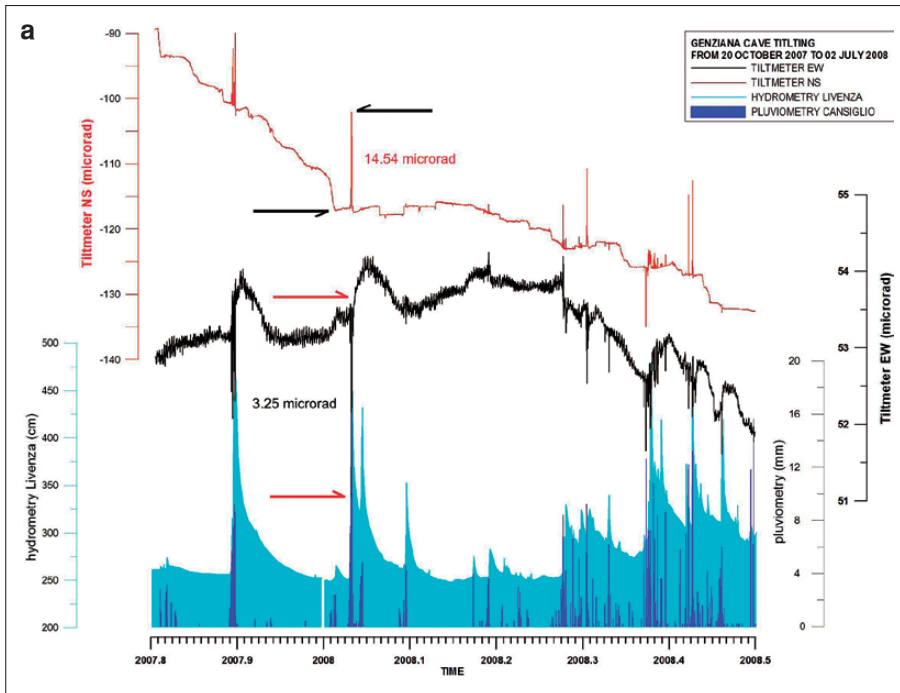
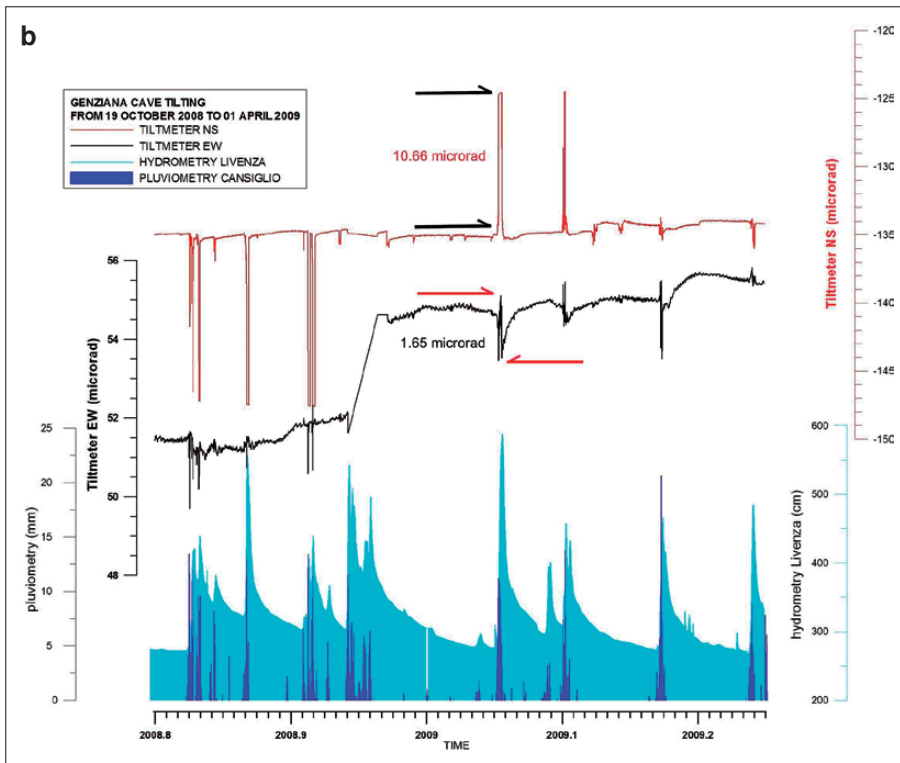

Fig. 6: The tilting signal of the EW and NS components compared with the hydrometry of Livenza and the rainfall of Cansiglio (hourly values) from 20 July 2007 until 2 July 2008 (a) and from 19 October 2008 until 2 April 2009 (b). a) The hydrologic signal is evident in the spikes and “loops” in correspondence to rain events, which sometimes manifests itself as a slow drift correlating with the runoff curves of the aquifer. b) Analysing the end of 2008 and the beginning of 2009 the curves are always correlated with the runoff of the aquifers, but particularly in December 2008 one observes after an intense precipitation a rough shift in the direction southeast that is then maintained in the following months. When the rainfall exceeds 10 mm/hour, the EW impulsive signal is about 1.65 μ rad and the NS tiltmeter signal is 10.66 μ rad.



is filled in one to two days to the maximum level, unloading subsequently through an outlet at its base, one obtains a consecutive eastward tilting after about two additional days with slow recovering. The outlet of the basin causes the returning of the signal EW to the point of origin. This behaviour could correspond to the signals observed in Fig. 6a. The recordings of the tiltmeters show that this situation can change over time: the southward tilting during the year 2008

the tiltmeter station charges a basin located east of the station. A high flow in the channel will cause an impulsive northward tilting of the NS tilt component. If the runoff comes from west toward east, the excursion of the component EW will follow the full load, and will be oriented first to the west, and then to the east. If the basin

(Fig. 6b) can be explained by the course variation of the runoff waters, which has occurred for some months in a channel south of the station. The heavy rainfalls at the end of 2008 have probably modified the permeability of the underground courses, as shown by the fact that the tilting signal is orientated again toward the north.

In correspondence with this inversion of tendency of the NS component, in the EW component a clear shifting toward the east is seen. Unlike before (Fig. 6a), the movement of the full load arrives with more delay with respect to the maximum load, with a later discharge following the exponential rule.

The loading at west and runoff at east is compatible with the hydrologic configuration of the massif, which in its southeastern part has the belt of springs of the Livenza river. But the observed tilt variations can be explained only by a non-homogeneous hydrology of the karstic

system, and with the fact that the hydrologic system west of the station has different hydrologic characteristics than the eastern one.

The Marussi tiltmeters can be useful for the detection of this type of loading and can provide information on the typical time constants of the hydrologic cycle of the massif. The good correlation of the tilt signals with the springs of the Livenza river, which is about 10 km from the tiltmeter station, demonstrates the tilt senses regional and not only local effects.

COMPARISON WITH GPS OBSERVATIONS

Considering the evident signal of deformation induced by underground runoff waters, we evaluated the possibility that this deformation could be surveyed with GPS instrumentation. In the area of Cansiglio a unique permanent GPS station (CANV) has been installed by the National Institute of Oceanography and Experimental Geophysics (INOGS) in 2004 and is part of the monitoring GPS network of the Friuli area (FREDNET). The GPS station is situated at about 800 m height in the external Friulian of the Cansiglio-Cavallo Plateau and at a distance of about 8 km from the Genziana cave tiltmeter. The GPS data have been analyzed with the program Bernese (v.5.0) (Beutler

et al. 2007) in the framework of a network solution including about 40 permanent GPS stations in the area of the northeastern Alps. Daily positions have been estimated for all stations and then represented in the ITRF2005 reference system following the data processing scheme as described in Devoti *et al.* (2008). The time series were then expressed with respect to a fixed Eurasian plate in which the secular trends represent the local tectonic behaviour with respect to the northern Alps. In Fig. 7 the observed displacements in the east and north direction of the GPS station Caneva (CANV) are shown in red, together with the hydrologic and tiltmeter data. The average error associated with the horizontal displacements is typically on the order of a few millimeters (about 3 mm for CANV). The tilt components (in magenta) show sudden variations (back-and-forth) associated with heavy rainfall (> 70 mm in a day, dark blue bars) and subsequently a slow deformation pattern,

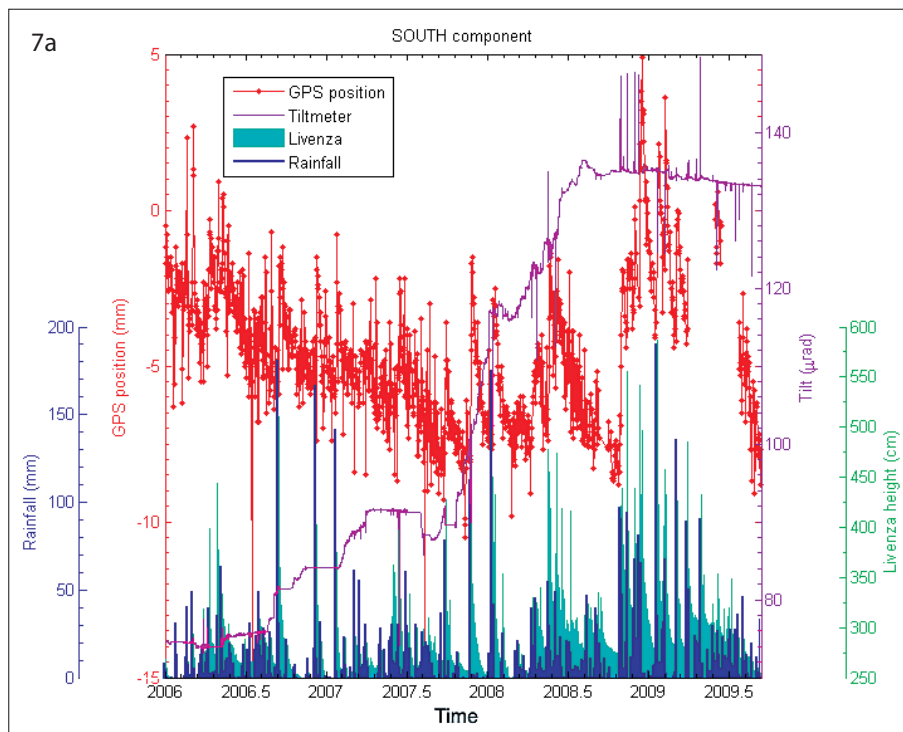

et al. 2007) in the framework of a network solution including about 40 permanent GPS stations in the area of the northeastern Alps. Daily positions have been estimated for all stations and then represented in the ITRF2005 reference system following the data processing scheme as described in Devoti *et al.* (2008). The time series were then expressed with respect to a fixed Eurasian plate in which the secular trends represent the local tectonic behaviour with respect to the northern Alps. In Fig. 7 the observed displacements in the east and north direction of the GPS station Caneva (CANV) are shown in red, together with the hydrologic and tiltmeter data. The average error associated with the horizontal displacements is typically on the order of a few millimeters (about 3 mm for CANV). The tilt components (in magenta) show sudden variations (back-and-forth) associated with heavy rainfall (> 70 mm in a day, dark blue bars) and subsequently a slow deformation pattern,

Fig. 7: Comparison between the horizontal components NS (a) and EW (b) of the GPS station Caneva (red), the tilting signal of station Genziana (magenta), pluviometrical recordings of the Cansiglio area (blue) and hydro-metric signal of River Livenza (cyan).

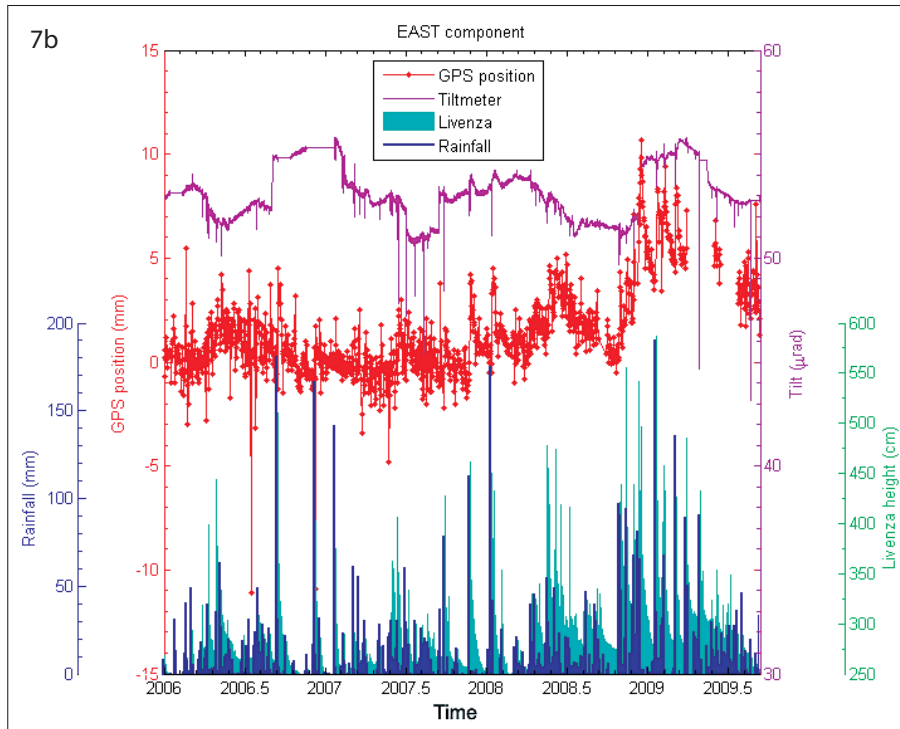

more pronounced in the east component. The GPS and tiltmeter changes in time series are highly correlated with the hydrological cycle; high rainfall episodes induce sudden changes (probably in one to two days) of the GPS position in the S-SE direction, followed by a slow return to the original position, whereas the tiltmeter does not tilt in a single direction; it promptly responds to the water

load in a back-and-forth style mainly in the N-S direction followed by a slow relaxation phase. The heavy rainfall of autumn 2008, when the GPS station advanced toward the SE by about 15 mm. The EW component tilt data of the same period show a pronounced and permanent eastward movement (Fig. 9) of about 3 μ rad.

During all rainfall events both GPS and tiltmeter stations recorded an instantaneous deformation caused

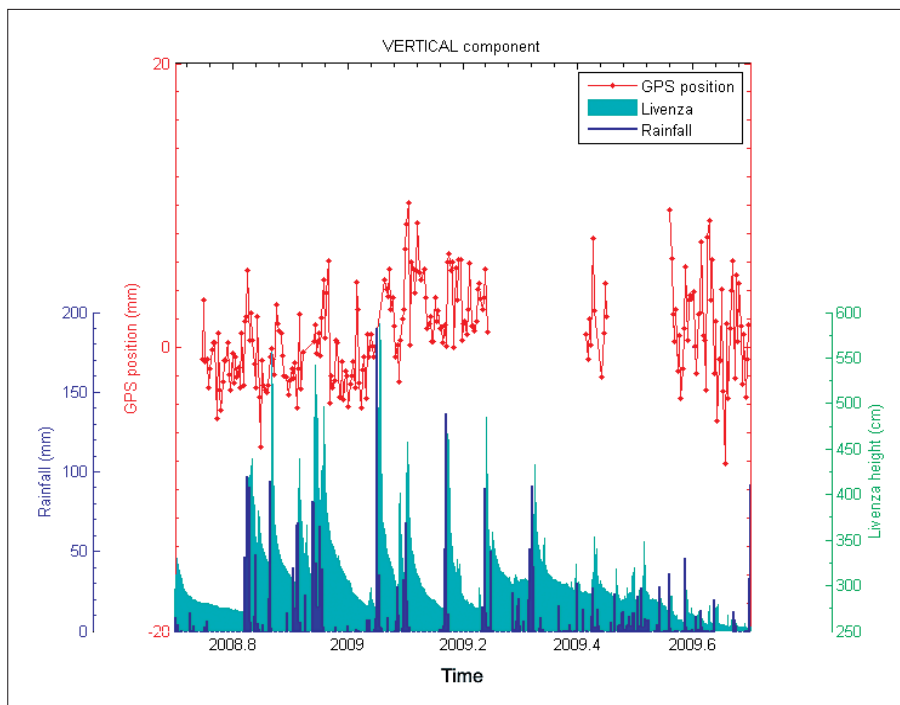

by the hydrological loading, associated with the water flow in underground conduits (phase of full load). The following long-term responses of the deformations have to be ascribed to the water runoff from the rock matrix toward the conduits (runoff phase).

In case of abundant rainfall the GPS station records a fast horizontal displacement towards the S-SE on the order of 4 to 6 mm, in 1 or 2 days (the daily positions do not allow resolution), and then it returns back slowly to the original position in the following weeks. The vertical component does not show significant variations in correspondence to the rainy events (Fig. 8); nevertheless due to the higher noise level (RMS = 4-5 mm), we cannot exclude vertical movements below that level. An exceptional event occurred during

the heavy rainfall of autumn 2008, when the GPS station advanced toward the SE by about 15 mm. The EW component tilt data of the same period show a pronounced and permanent eastward movement (Fig. 9) of about 3 μ rad.

Fig. 8: Comparison among the vertical component of the GPS Caneva position, the pluviometric signal (mm/day) of Consiglio and the hydrometric signal of the River Livenza from 19 October 2008 until 2 April 2009. The vertical displacements do not show a distinct correlation with the runoff of aquifers.

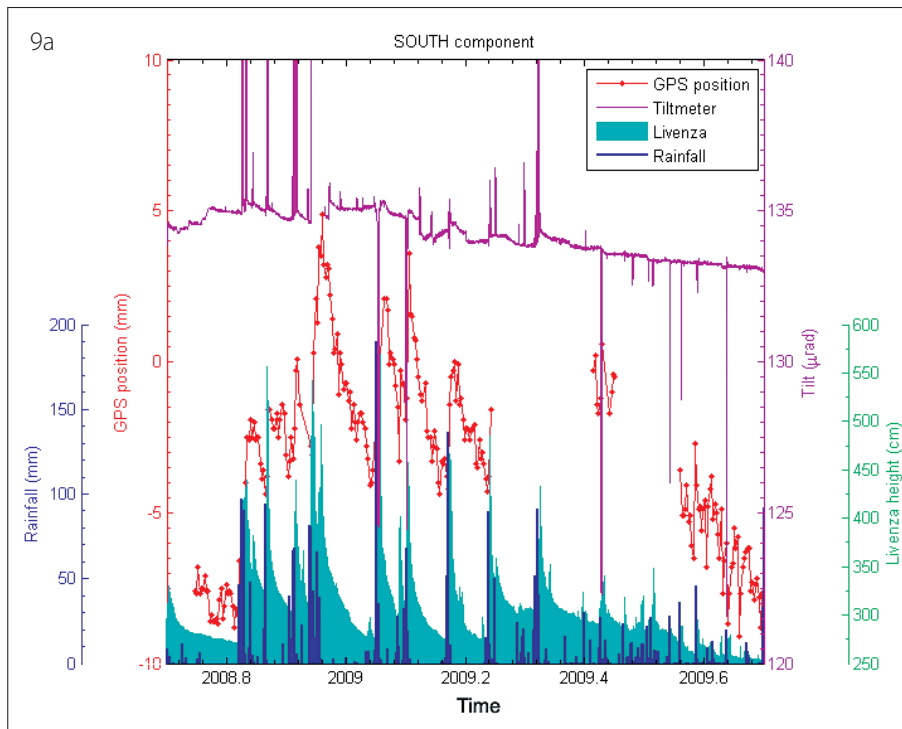
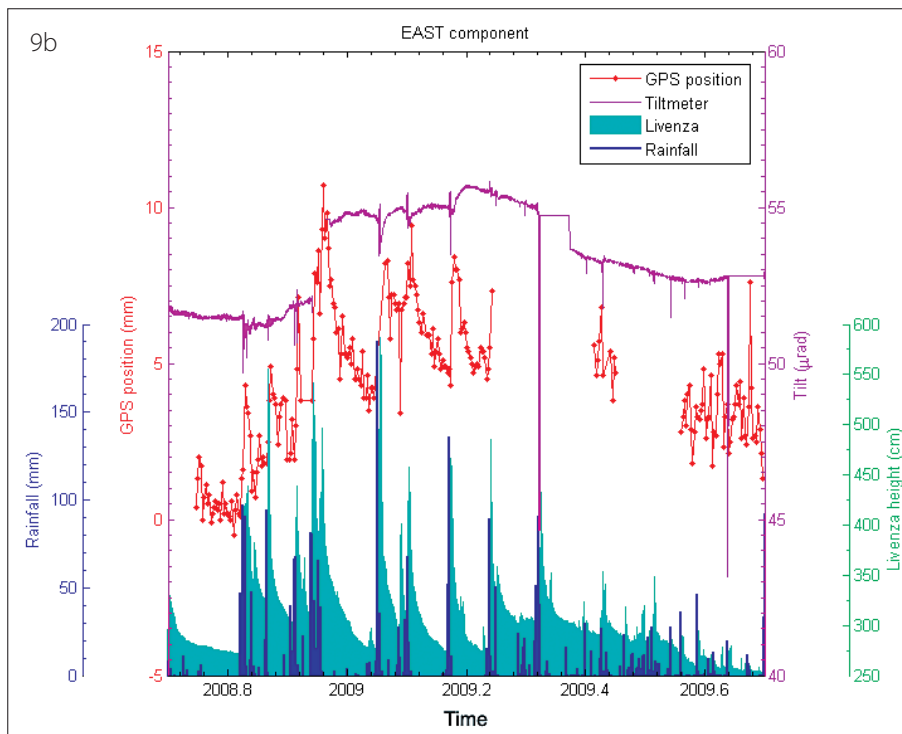

Fig. 9: Comparison between the horizontal components NS (a) and EW (b) of the GPS station Caneva, the tilting signal of station Genziana, pluviometrical recordings (mm/day) of Cansiglio and hydrometric signal of River Livenza from 19 October 2008 to 2 April 2009. The tilting signal is violet. The satellite signal is red. Both of them register simultaneously the rain event. The scale on the ordinates permits quantification of the displacement induced by hydraulic loading. The hydrologic signal is evident at the spikes and “loops” in correspondence with rain events, which sometimes appears like a slow drift equal to runoff curves of the karstic aquifers.



time. In this assumption the time needed to discharge the basin is:

$$\tau = \sqrt{\frac{2H_0}{g} \left[\left(\frac{S_1}{S_2} \right)^2 - 1 \right]}$$

Assuming an area of $S_1=10 \times 10 \text{ km}^2$ of the Cansiglio basin, a discharging conduit section of $S_2=4 \times 4 \text{ m}^2$, a water table height of $H_0=100 \text{ mm}$ and g being the gravity acceleration, the emptying time for the basin results in 10.3 days. Given the rough assumption of the S1 area the uncertainty on the derived emptying time is on the order of one to two days, but nevertheless it is highly consistent with the observed GPS runoff deformation patterns, thus reinforcing the idea of a runoff induced deformation of the entire karstic system.

To get a first guess of the time constant for the runoff phase we evaluated the time needed by the rainwater to drain out of a basin through a single spring. In the Bernoulli approximation (valid for ideal fluids) the runoff velocity is proportional to the height of the water table and the water table level is decaying quadratically in

reinforcing the idea of a runoff induced deformation of the entire karstic system.

Different hydrologic supply mechanisms in the karstic massif have been strengthened recently. A substantial relationship exists between the chemistry of the water of some cavities of the Cansiglio Plateau and

the water sources of the Livenza (Grillo 2007; Cucchi *et al.* 1999), confirmed also by recent tracing tests in the Abyss Col del Rizza. But the extension of the basin and the dynamics of the karstic hydrology of the Cansiglio-Cavallo Plateau remain fairly unknown. The possibility to improve the knowledge of the ongoing deformation processes caused by water runoff by correlating different geodetic measurements (GPS and classical meth-

ods) and other geological and speleological observations could certainly contribute to the understanding of underground water circulation. To measure the extent and the style of the deformation a small network of geodetic markers need to be set up on the entire massif. Surveying the marker points with a few GPS receivers could help to assess the limits of the deformation area and the behaviour of the ongoing deformation.

CONCLUSIONS

The geodetic station located in Bus de la Genziana is situated in a strategic logistic position from a geophysical and hydrogeologic point of view, as the Cansiglio - Cavallo Plateau represents one of the most interesting karstic areas of northeast Italy. It has been verified that the cave deforms continuously and is particularly sensitive to meteorological variations; the tectonic tilting is directed towards the south with semicircles which occur in correspondence to heavy rain events. The tilting reflects the actual tectonic situation in northeast Italy, which shows the convergence of the Adriatic and Euroasiatic plates.

The tilting signal gives information on the characteristics and location of the underground runoff of rainwater. In the case of Cansiglio a rapid runoff has been ascertained which normally passes to the north from the Genziana station, in the direction from west to east, which loads a basin situated east of the station. The runoff occurs mainly vertically and/or towards the east; otherwise a N-S tilting signal should have been observed. For a limited period of time the course of the full load occurred south of the station, flowing from east to west. Presently we have not investigated possible effects of the water table height changes in the Veneto and Friuli plane, which extends from the foot of the massif towards the Adriatic Sea. This shall be approached in a further study.

The GPS shows a sudden shift towards the S-SE during heavy rain events and a smooth recovering of the original position in the following weeks, resembling the height level of the Livenza River. It does not show big variations in the observed deformation patterns.

The comparison between tiltmeter and GPS data shows the contemporaneous recording of atmospheric events. Both instruments record slow deformations after rain events in connection with the hydrometry of the karstic aquifers (curves of Livenza's runoff); the GPS station displaces in a horizontal plane and then returns to the original position without particular signals in the vertical component.

Both geodetic stations record the hydraulic loading at the same times, reflecting the fluid flow in the underground conduits during the phase of full load. The slow (weeks) long term response is a deformation which could be the runoff of water from the rock matrix towards the conduits in the phase of normal water flow. The variation in direction of the tilt impulses could be derived from the non-homogeneous hydrology of the karstic system and from the presence at least of two areas, one situated west and one east of the station, with different hydrogeologic characteristics. This deformation is probably not of tectonic origin, because the Livenza spring also shows these signals.

The future goals are to intensify the network of GPS and tiltmeters with more stations in order to evaluate the deformations induced by hydraulic loading. Considering the evident hydrologic effects induced in the geodetic measurements, we believe our study can open a new frontier for the study of karstic aquifers and permit a better understanding of underground fluid flow circulation.

ACKNOWLEDGEMENTS

We thank Alberto Casagrande for constant engagement and for precious collaboration, l'ARPA Veneto Teolo Meteorologic Center for the concession of meteorologic data, Ing. Giorgio Della Chiesa (Central Environmental Management and Public Works – Hydrographic Unit – Friuli Venezia Giulia Region) for the hydrometric data of Livenza, Dr. David Zuliani (National Institute of

Oceanography and Sperimental Geophysics Trieste) for the prompt availability of the GPS data, and Dr. Carlo Dilena and the Forest Command of Pian Cansiglio for hospitality, collaboration and courtesy. Thanks also to Corinna Kroner and Thomas Jahr for their comments and meticulous review.

REFERENCES

- ARPA FVG, 2006: *Rilevamento dello stato dei corpi idrici sotterranei della Regione Friuli Venezia Giulia, (Survey on the state of underground hydrologic units of the Friuli Venezia Giulia Region).*- Regione Autonoma Friuli Venezia Giulia, Final Report, pp. 68-71, [Online] Available from: http://www.regione.fvg.it/rafv/export/sites/default/RAFVG/AT9/ARG1/FOGLIA5/modulistica/relazione_totale.pdf.
- Beutler, G., Bock, H., Dach, R., Fridez, P., Gade, A., Huentobler, U., Jaggi, A., Meindl, M., Mervant, L., Prange, L., Schaer, S., Springer, T., Urschl, C. & P. Walsler, 2007: Bernese GPS Software Version 5.0.- In: Dach, R. et al. (eds.), *Bernese GPS Software Version 5.0. Astronomical Institute, University of Bern*, pp. 612, Bern.
- Braitenberg, C., 1999a: The Friuli (NE Italy) tilt/strain gauges and short term observations.- *Annali di Geofisica*, 42, 1-28.
- Braitenberg, C., 1999b: Estimating the hydrologic induced signal in geodetic measurements with predictive filtering methods.- *Geophys. Res. Letters*, 26, 775-778.
- Braitenberg, C., 1999c: The hydrologic induced strain – a review.- *Bulletin d'Information des Marees Terrestres*, 131, 1071-1081.
- Braitenberg, C. & M. Zadro, 1999: The Grotta Gigante horizontal pendulums – instrumentation and observations.- *Boll. Geof. Teor. Appl.*, 40, 3/4, 577-582.
- Braitenberg, C., Nagy, I. & B. Grillo, 2005a: Alcune informazioni sulla stazione geofisica ipogea della Grotta Gigante (Carso Triestino) (Some information on the geodetic-geophysical underground station of Grotta Gigante (Trieste Karst)).- *Progressione*, 52, 60-69.
- Braitenberg, C., Romeo, G., Taccetti, Q. & I. Nagy, 2005b: The very-broad-band long-base tiltmeters of Grotta Gigante (Trieste, Italy): secular term tilting and the great Sumatra-Andaman Islands earthquake of December 26, 2004.- *J. of Geodynamics*, 41, 164-174.
- Braitenberg, C., Grillo, B., Nagy, I., Zidarich, S. & A. Piccin, 2007: La stazione geodetico - geofisica ipogea del Bus de la Genziana (1000VTV) - Pian Cansiglio, (The geodetic-geophysical underground station of Bus de la Genziana).- *Atti e Memorie della Commissione Grotte "E. Boegan", Società Alpina della Giulie CAI, Trieste, Italia*, 41, 105-120.
- Cancian, G. & S. Ghetti, 1989: Stratigrafia del Bus de la Genziana (Cansiglio, Prealpi Venete). (Stratigraphy of Bus de la Genziana (Cansiglio, Venetian Prealps)).- *Studi Trentini Sc. Nat. Acta Geol.*, Trento, 65, 125-140.
- Cucchi, F., Forti, P., Giacconi, M. & F. Giorgetti, 1999: *Note idrogeologiche sulle sorgenti del Fiume Livenza (Hydrological notes on the Livenza springs).*- Ricerca eseguita dall'Unità 4.7 e dall'Unità 4.9 del Gruppo Nazionale Difesa Catastrofi Idrogeologiche del C.N.R., Pubb. n° 1831.
- Devoti, R., Riguzzi, F., Cuffaro, M. & C. Doglioni, 2008: New GPS constraints on the kinematics of the Apennines subduction.- *Earth and Planetary Science Letters*, 273, 163-174.
- Doglioni, C., 1990: Thrust tectonics examples from Venetian Alps.- *Stud. Geol. Camerti*, special issue, 117-129.
- Galadini, F., Poli, M. & A. Zanferrari, 2005: Seismogenic sources potentially responsible for earthquakes with $M > 6$ in the eastern southern Alps (Tiene - Udine sector, NE Italy).- *Geophys. J. Int.*, 161, 739-762.

- Grillo, B., 2007: Contributo alle conoscenze idrogeologiche dell'Altopiano del Cansiglio. (New insights to the Cansiglio Plateau hydrology).- *Atti e Memorie della Commissione Grotte "E. Boegan"*, 41, 5-15.
- Longuevergne, L., Florsch, N., Boudin, F., Oudin, L. & C. Camerlynck, 2009: Tilt and strain deformation induced by hydrologically active natural fractures: application to the tiltmeters installed in Sainte-Croix-aux-Mines observatory (France).- *Geophys. J. Int.*, 178, 667-677.
- Pettenati, F. & L. Sirovich, 2003: Source inversion of intensity patterns of earthquakes: a destructive shock in 1936 in the northeast Italy.- *Journal of Geophysical Research*, 109, B10309.
- Vincenzi, V., Riva, A. & S. Rossetti, 2010: Towards a better knowledge of Pian Cansiglio karst system: results of the first successful tracer test in groundwater.- *Acta Carsologica*, in press.
- Weise, A., Jentzsch, G., Kiviniemi, A. & J. Kaariainen, 1999: Comparison of long-period tilt measurements: results from the two clinometric stations Mets"ahovi and Lohja, Finland.- *J. Geodyn.*, 27, 237-257.
- Zadro, M. & C. Braitenberg, 1999: Measurements and interpretations of tilt-strain gauges in seismically active areas.- *Earth Science Reviews*, 47, 151-187.
- Zuliani, D., 2003: FREDNET: rete di ricevitori GPS per la valutazione del potenziale sismico nelle Alpi sudorientali italiane (FREDNET: GPS network for the evaluation of the seismic potential of the south-oriental Italian Alps).- In: *GNGTS, Atti del 22° Congresso Nazionale*, 18th-20th November 2003, 16-17, Rome.