

## Zgodnjerimska ladja iz Ljubljance pri Sinji Gorici

### Early Roman barge from the Ljubljana River at Sinja Gorica

Miran ERIČ, Andrej GASPARI, Katarina ČUFAR, Franc SOLINA, Tomaž VERBIČ

#### Izvleček

Med preventivnimi podvodnimi arheološkimi pregledi struge Ljubljance pri Sinji Gorici leta 2008 so bili med drugim odkriti ostanki zgodnjerimske tovarne ladje z začetka 1. st. n. št. Oktobra 2012 je bil delno raziskan 4,5 m dolg in 2,8 m širok del ladje z ravnim dnom in navpičnimi boki. Za dokumentiranje je bilo uporabljeno fotogrametrično trirazsežno modeliranje. Po konstrukcijskih značilnostih in merah gre za rimsko tovarno ladjo sredozemske ladjedelniške tradicije, podolgovate ovalne oblike z ravnim dnom in samonosilno lupino, ki je bila med gradnjo spojena s številnimi železnimi spojki, zabitimi čez stike platic. Ladijski trup je bil dodatno spet s talnimi tramiči na način, ki doslej v literaturi še ni bil opisan. Ladja, izdelana pretežno iz bukovega lesa, je bila glede na rezultate dendrokronološke analize zgrajena kmalu po letu 3 našega štetja. Pregled je pokazal, da je les zelo slabo ohranjen. Sklepamo, da je bila ladja uporabljena za prevoz tovora med Nauportom in Emono.

**Ključne besede:** rimska doba, Ljubljana, Sinja Gorica, *Nauportus*, zgodnjerimska tovarna ladja, podvodna arheologija, fotogrametrični 3R-model

#### Abstract

Preventive underwater archaeological surveying in the bed of the Ljubljana River, conducted at Sinja Gorica in 2008, revealed the remains of an Early Roman wooden barge from the beginning of the 1<sup>st</sup> century AD. Detailed documentation of the 4.5m long and 2.8m wide section of the boat followed in October 2012 and included photogrammetric three-dimensional modelling. The construction characteristics and size revealed a boat of the Mediterranean shipbuilding tradition, with an elongated oval shape and a flat bottom and vertical sides, constructed using the shell-first technique and planks fastened with iron clamps, while the hull was reinforced with floor-timbers in a manner not yet published in the relevant literature. The barge, made mostly of beech wood, was built soon after AD 3 according to the dendrochronological analysis. The wood is very poorly preserved. The barge was presumably used to transport cargo between Nauportus and Emona.

**Keywords:** Roman period, the Ljubljana River, Sinja Gorica, *Nauportus* (Vrhnika), Early Roman barge, underwater archaeology, photogrammetric 3D model

1. Uvod ( <i>Miran ERIČ</i> ) .....	188
Terenski pregled leta 2008 .....	188
Najdiščne okoliščine .....	190
Terensko delo leta 2009 in 2012 .....	190
2. Stratigrafska lega ( <i>Tomaž VERBIČ, Miran ERIČ</i> ) .....	191
3. Dokumentiranje ( <i>Franc SOLINA, Miran ERIČ</i> ) .....	193
4. Datacija, vrste lesa in ohranjenost ( <i>Katarina ČUFAR, Miran ERIČ</i> ) .....	195
Radiometrična datacija .....	195
Identifikacija lesa in dendrokronološko datiranje .....	197
Ohranjenost lesa .....	199
5. Ladijska zgradba ( <i>Miran ERIČ</i> ) .....	200
Konstrukcijski elementi .....	200
Čolnici .....	200
Bočna in talne platice .....	201
Talna tramiča .....	201
Bočna tramiča .....	204
Tesnjenje in spajanje .....	204
Obdelave, sledi uporabe in drugo .....	209
6. Zaporedje gradnje in oblika ( <i>Miran ERIČ</i> ) .....	209
Zaporedje .....	209
Oblika .....	211
7. Primerjalna analiza konstrukcijskih in tehnoloških značilnosti ladje in njeno mesto v regionalnih ladjedelniških praksah ( <i>Andrej GASPARI</i> ) .....	213
8. Sklep .....	223
9. Katalog ( <i>Miran ERIČ</i> ) .....	224
Literatura .....	228

## 1. UVOD

### Terenski pregled leta 2008

Skupina za podvodno arheologijo (SPA) Zavoda za varstvo kulturne dediščine Slovenije (ZVKDS) je v okviru zaščitnega posega pred vzdrževalnimi deli – utrjevanjem desne brežine – septembra 2008 opravila podvodne terenske preglede okoli 200 m dolgega odseka Ljubljanice pri Sinji Gorici (*sl. l: c*).<sup>1</sup> Intenzivni podvodni pregled potencialno ogroženega območja struge Ljubljanice (Evidenčna številka dediščine 11420) vzdolž parc. št. 1100,

1125, in 1865/1 k. o. Verd je bilo opravljen pod okriljem ZVKDS, Območne enote Ljubljana.<sup>2</sup>

V 44 kvadrantih je bilo med pregledom odkritih okoli 2.500 predmetov, večinoma odlomkov prazgodovinskega, rimskega, srednjeveškega, novoveškega in modernega keramičnega posodja in gradbenega materiala. Med najdbami izstopajo zgodnjerska fibula tipa Aucissa, okoli 10 kg težka, časovno neopredeljena železna pogača (ingot) ter paleolitska lesena konica, najverjetneje del lovskega orožja človeka, ki je živel pred približno

<sup>2</sup> Terensko skupino so sestavljali Miran Erič iz SPA ZVKDS, potapljači Društva za raziskovanje morja Ljubljana Rok Kovačič, Marko Gasparič in Oskar Musić, potapljači športnega društva Trident Gašper Košir, Anže Košir, Marjan Vidmar in Zlatko Kovač ter Matej Draksler in geodetski tehnik Marko Gaspari.

<sup>1</sup> Erič, Gaspari 2009a; Erič et al. 2009.

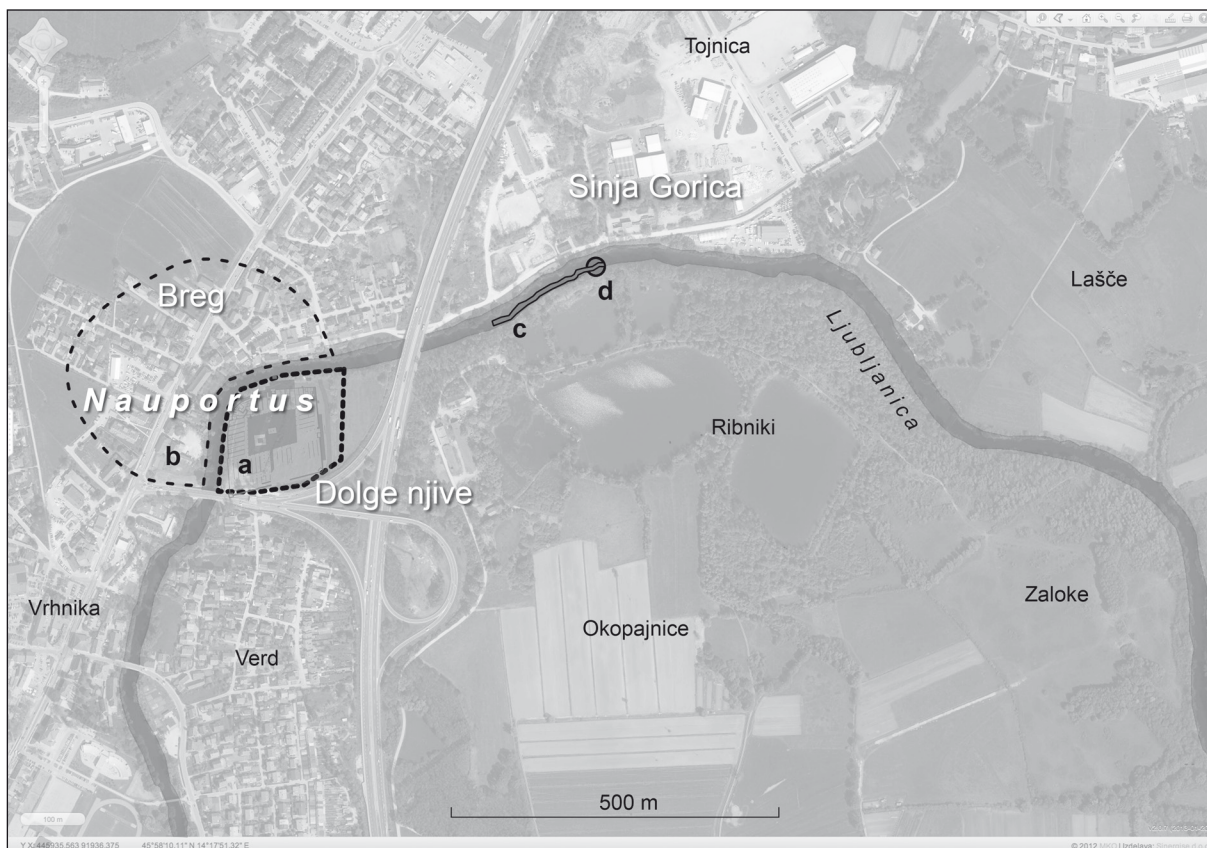

Sl. 1: Severovzhodno območje Vrhnika z rimsko naselbino. **a** – Dolge njive; **b** – Breg (Mušič, Horvat 2007); **c** – območje zaščitnih pregledov leta 2008; **d** – območje raziskave ladje v Ljubljani pri Sinji Gorici leta 2012.

Fig. 1: Area north-east of Vrhnika with the Roman settlement. **a** – Dolge njive; **b** – Breg (Mušič, Horvat 2007); **c** – area of the 2008 survey; **d** – area of the 2012 barge documentation in the Ljubljana River at Sinja Gorica.

(Podlaga / Based on ©GERK MKO)

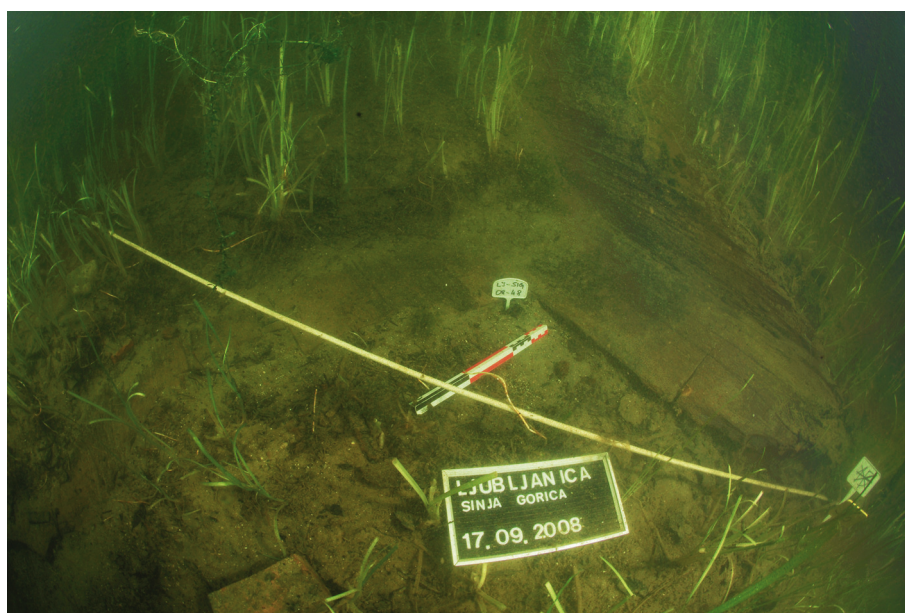

Sl. 2: Ljubljana pri Sinji Gorici. Stanje plovila ob odkritju septembra leta 2008.

Fig. 2: The Ljubljana at Sinja Gorica. State of the vessel upon discovery in September 2008.

(Foto / Photo: M. Gasparič)

45.000 leti.<sup>3</sup> Skupina je na skrajnem vzhodnem delu pregledanega območja ob kvadrantih 35 in 36 odkrila tudi lesene dele ladje (*sl. 1: d; 2*)<sup>4</sup> z levo in desno bočno čolnico, ravnim dnom, sestavljenim iz petih talnih platic, in železnimi spojkami. Ostanke ladje so ležali vodoravno in izginjali pod sedimente brežine. V neposredni bližini ladje je bilo odkritih tudi 15 prostoležečih železnih spojk in 2 kovana žebnja, ki domnevno pripadajo ladji (*t. 1*). Med pregledi je bila ugotovljena približna širina med obema čolnicama okoli 2,4 m. Na podlagi širine in datacije plovila je bilo mogoče sklepati, da gre za 12 do 15 m dolgo ladjo iz zadnjih desetletij pred našim štetjem ali prvih desetletij našega štetja.

### Najdiščne okoliščine

Odkritje ladje v Ljubljani pri Sinji Gorici (odslej: ladja iz Sinje Gorice) ni naključje iz dveh razlogov. Prvi so naravne razmere na Ljubljanskem barju in v Ljubljani, ki so izjemno ugodne za ohranjanje lesenih najdb. Hidrogeološke in geomorfološke značilnosti Ljubljanskega barja, zlasti visok nivo podtalnice, zagotavljajo izjemno ugodne pogoje za ohranitev organskih snovi. Na tako naravo Barja kaže tudi množica odkritih deblakov in plovil, ki jih je na tem območju danes najmanj 76,<sup>5</sup> z za zdaj najstarejšima dendrokronološko datiranimi deblakoma (3211 in 3136 pr. n. št.) s količca Stare gmajne,<sup>6</sup> ter nekaj deblaki, datiranimi v 1. st. pr. n. št. in 1. st. n. št.<sup>7</sup>

Do pomembnega odkritja je prišlo oktobra leta 1890 na območju Brezovega loga v Lipah, na posestvu Josipa Kozlerja, med kopanjem odtočnega

jarka. Delavci so takrat naleteli na 30 m dolgo in 4,8 m široko ladjo, ki velja za eno najbolj ohranjenih antičnih plovil nasploh (odslej: ladja iz Lip). Alfons Müllner, kustos deželnega muzeja, ki je ladjo dokumentiral, je na podlagi stratigrafske lege plovila menil, da je predrimska.<sup>8</sup> Z radiometričnimi datacijami je bila gradnja ladje umeščena v drugo polovico 1. st. pr. n. št. ali na sam začetek 1. st. n. št.<sup>9</sup> Plovilo je zaradi svojih konstrukcijskih značilnosti pogosto obravnavano med raziskovalci antičnega ladjedelništva.

Druga pomembna okoliščina najdbe pri Sinji Gorici je, da je bila ladja odkrita le okoli 300 m vzhodno od zgodnjericimske naselbine s skladišči in pristaniščem v okljuku Ljublanice na Dolgih njivah (*sl. 1: a*), obdane z obzidjem in obrambnim jarkom.<sup>10</sup> Naselbina na Dolgih njivah je bila opuščena v prvi polovici 1. st. n. št., transportne dejavnosti in življenje pa so se dokončno preselili na Breg (*sl. 1: b*) vzdolž glavne ceste (*via publica*) med Akvilejo in Emono. Številne najdbe iz struge vzdolž naselbine in dolvodno potrjujejo tudi vojaški pomen območja.<sup>11</sup>

Na območju odkritja ladje je Ljublanica široka okoli 25 m, globina vode pa je od 2,5 do 4 m ob povišanih vodostajih. Struga je delno vrezana v rečne naplavine ter poznopleistocenske in zgodneholocenske jezerske sedimente. Dno je večinoma prekrito z obsežnimi peščenimi in muljastimi sipinami (*sl. 4: A,B*). Brežino med ribniki pri Sinji Gorici in Ljubljano so, da bi preprečili njeno rušenje, v 20. stoletju večkrat utrdili z lesenimi piloti in grobim kamnitim zasutjem. Ta zaščita se je v zadnjih desetletjih postopoma rušila.

### Terensko delo leta 2009 in 2012

SPA je pod okriljem Centra za preventivno arheologijo ZVKDS maja 2009 izvedla neinvazivno dokumentiranje odkritih lesenih delov plovila, sočasno pa je tudi preverila razmere po osmih mesecih od odkritja.<sup>12</sup> Ugotovljeno je bilo, da

<sup>3</sup> Gaspari, Erič, Odar 2011; 2012.

<sup>4</sup> Na globini 2,5 m pod srednjo gladino vode in absolutni nadmorski višini 284,11 m ter koordinatah GK y 446827, x 92200.

<sup>5</sup> Več o deblakih in plovilih Hohenwarth 1838, 79, 87, 89; Dežman 1858; 1878; Müllner 1892a; 1894; 1897; Melik 1946, 71, op. 121; Erič 1994; 1998; 2008; 2009a; in dva neobjavljena elaborata, ki ju hrani Zavod za varstvo kulturne dediščine Slovenije: Curk, I. Nemeč, B. Vičič, D. Vuga, *Elaborat. Analiza konservatorskega problema v zvezi z lesom in drugimi organskimi ostalinami v arheoloških najdiščih* (Zavod SR Slovenije za varstvo naravne in kulturne dediščine, Ljubljana 1981) in P. Mali, D. Vuga, *Drevak iz Lip na Ljubljanskem barju* (Republiški zavod za spomeniško varstvo Ljubljana, Ljubljana 1978).

<sup>6</sup> Velušček, Veranič, Čufar 2009.

<sup>7</sup> Erič 2008, Vrhniški deblak I (SI-60) iz 1. st. n. št., Jelovškov deblak (SI-02) iz 1. st. pr. n. št., deblaka Krtine I. in II. (SI-04 in SI-05) iz 1. st. pr. n. št. in 2. st. n. št. ter Žitnikov deblak (SI-06) iz 1. st. n. št.

<sup>8</sup> Müllner 1890a; 1890b; 1892b.

<sup>9</sup> Več o ladji in okoliščinah Gaspari 1998a; 1998b; 2009a.

<sup>10</sup> Obširneje o raziskavah naselbine, okoliščinah in geostrateškem položaju Logar 1984; 1985; Horvat, Kocuvan, Logar 1986; Horvat 1990; 1996; 2009a; Gaspari 2002; Mušič in Horvat 2007.

<sup>11</sup> Več o najdbah npr. Horvat 1990; 1996; 2009a; Mušič, Horvat 2007; Gaspari, Erič 2002; 2006–2007; 2007; 2008.

<sup>12</sup> Erič 2009b; dokumentiranje sta opravila Miran Erič in Rok Kovačič, Golden Light Photography.

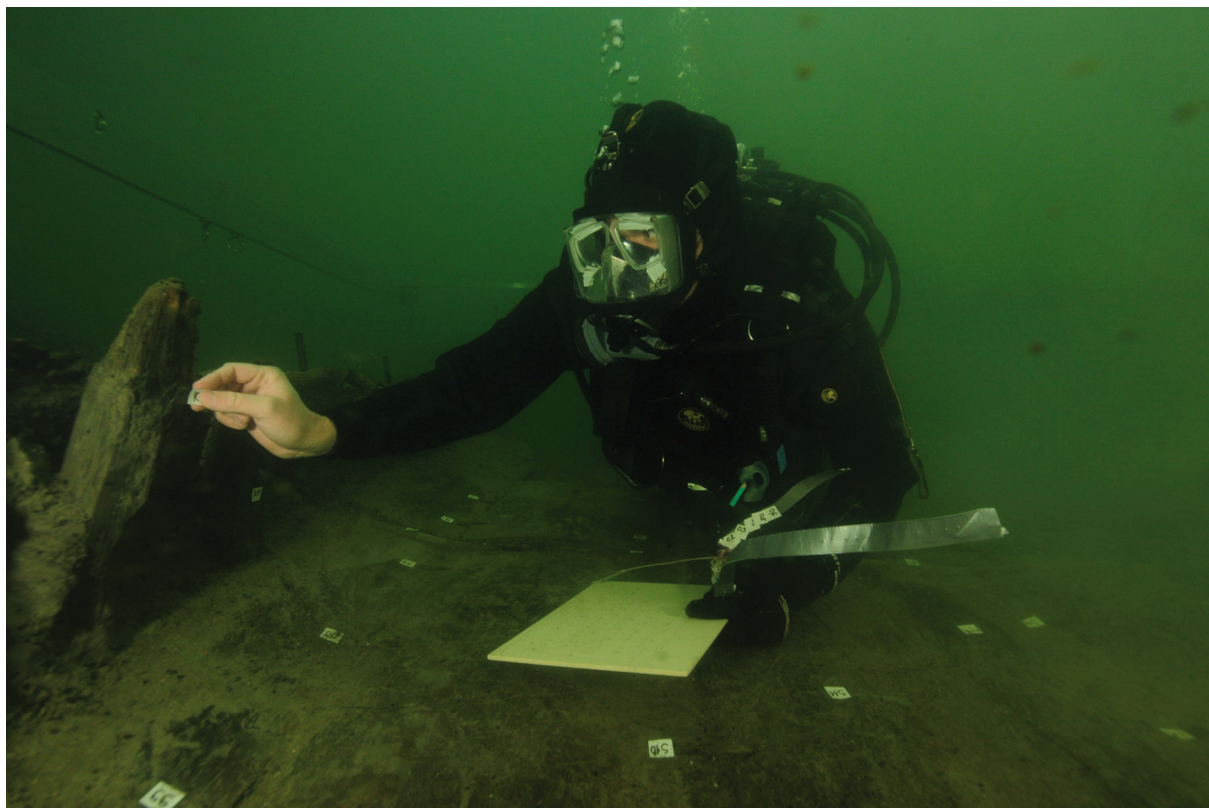

Sl. 3: Ljubljana pri Sinji Gorici. Označevanje elementov ladje za fotogrametrično 3R-modeliranje.  
 Fig. 3: The Ljubljana at Sinja Gorica. Marking barge elements for photogrammetric 3D modelling.  
 (Foto / Photo: R. Kovačič)

so bili zaradi posegov pri urejanju desne brežine odkriti ostanki ladje izpostavljeni erozijskemu delovanju vodnega toka in zato močno ogroženi.

Na pobudo ZVKDS je oktobra 2012 Ministrstvo za izobraževanje, znanost, kulturo in šport namenilo interventna sredstva za dokumentiranje ladje in premestitev ostankov v novonastajajoči državni depozitorij za moker les. Naloge raziskovalne skupine Centra za konservatorstvo ZVKDS so obsegale dokumentiranje plovila, vzpostavitev državnega depozitorija za moker les ter premestitev ostankov plovila v depozitorij. Skupina je bila sestavljena iz več manjših skupin sodelavcev in svetovalcev, k izvedbi terenskih del pa je z donacijami pomembno prispevala lokalna skupnost.<sup>13</sup>

V 23 delovnih dneh je 11 članov terenske skupine s strokovnimi sodelavci opravilo okoli 150 ur potopov za dokumentiranje ladje in 36 ur za pripravo lesene infrastrukture za depozitorij za moker les. Ladja brez tovora ali predmetov, ki bi jih bilo mogoče prepoznati kot ladijski inventar, je bila očiščena aktivnega recentnega sedimenta

v dolžini približno 4,2 m (sl. 3). Ob vzhodnem ladijskem boku je bilo mogoče čolnici slediti še približno 3 m, vendar ta del zaradi varnosti ni bil dokumentiran (glej sl. 4; 10).

Ker je ohranjene precej več ladje, kot je bilo pričakovano, je bil prvotni načrt, da se ostanki premestijo v depozitorij za moker les, spremenjen. Očiščeni del ladje je bil dokumentiran in po opravljenih delih zaščiteno s tanko plastjo mulja, prekrit z razgradljivimi protipoplavnimi mrežami iz jute ter obložen z vrečami s peskom.

Erič

## 2. STRATIGRAFSKA LEGA

Ladja leži v delu Ljubljane, kjer se njen tok takoj za Dolgimi njivami obrne proti vzhodu (sl. 1). Odkriti deli ladje se nadaljujejo v sedimente desne brežine pod kotom 46° v smeri 292° do 112° (ZSZ-VJV) na nadmorski višini med 283,90 in 284,60 m (sl. 4). Za razumevanje stratigrafskega položaja ladijske razbitine so bili iz desne brežine

<sup>13</sup> Erič, Šinkovec 2013.

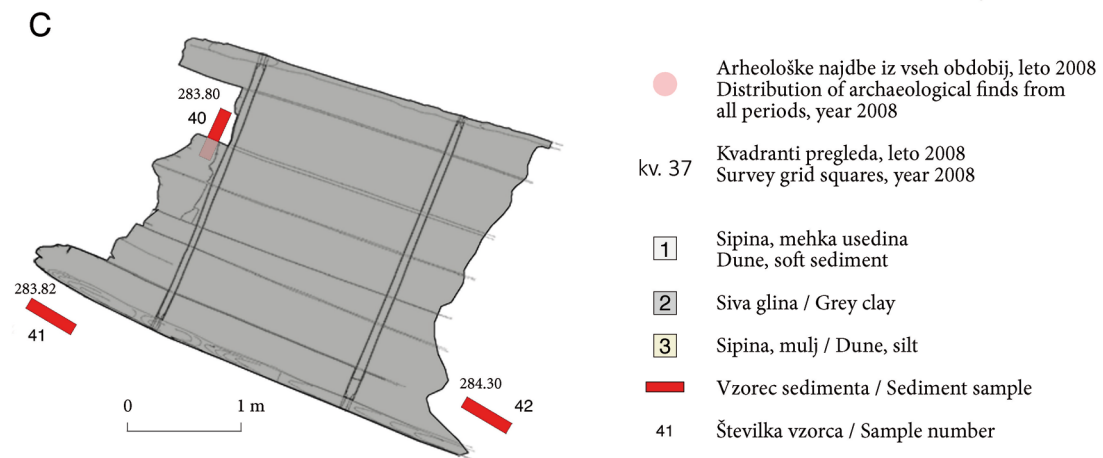
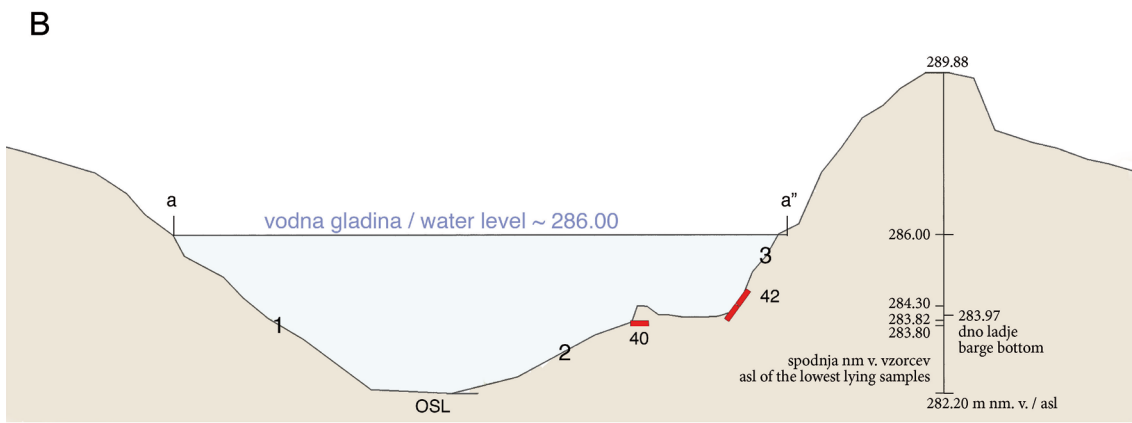
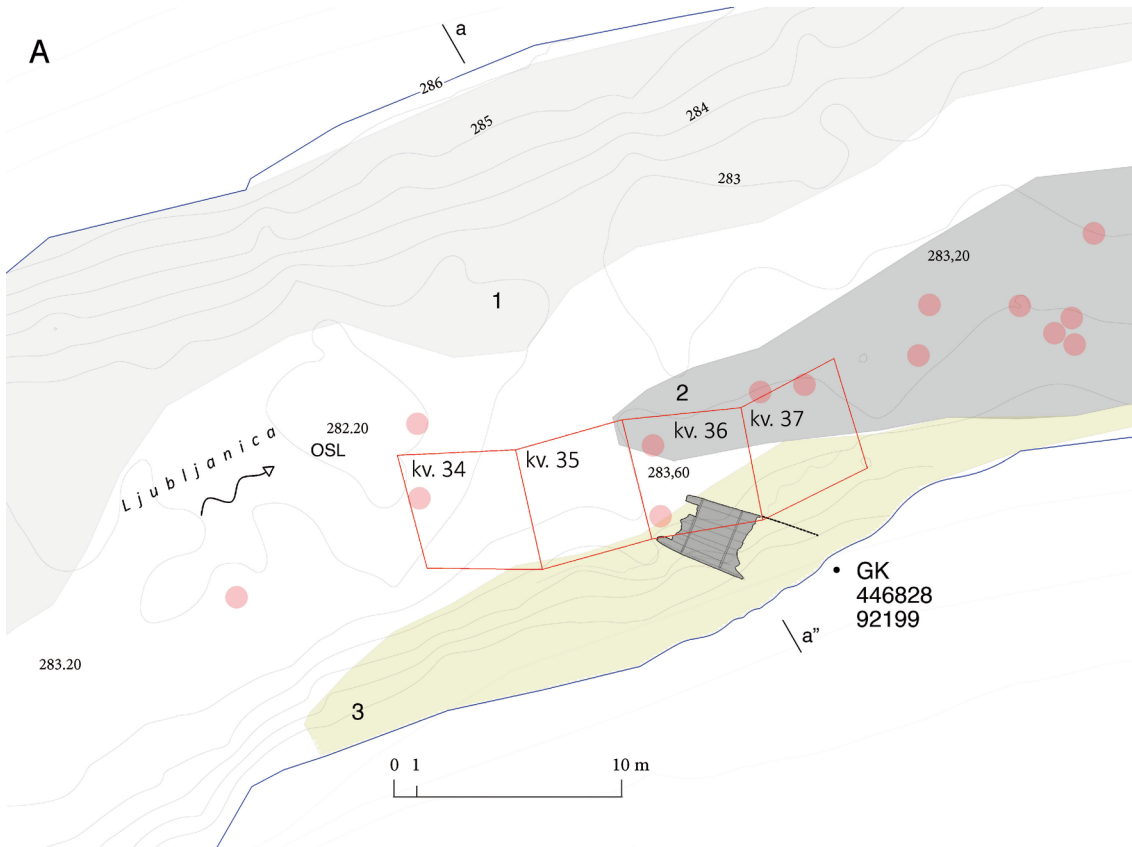

na višinah od 283,80 do 284,70 m nadmorske višine odvzeti trije vzorci sedimentov,<sup>14</sup> ki obsegajo sedimentno zaporedje ob ladji. Vzorci so bili pobrani s kalupom U oblike dolžine 50 cm s presekom 10 x 10 cm.

Vzorca 41 in 42 sta bila odvzeta v navpični legi, 40 pa v vodoravni (sl. 4). Vzorci so bili makroskopsko pregledani s terensko lupo ter testirani z reagenti.<sup>15</sup> Pri pregledu so bile ugotovljene štiri stratigrafske sekvence.

– V spodnjem delu, torej pod ladjo je bila ugotovljena plast 4 (vzorca 40 in 41; sl. 4: plast 4; sl. 5: plast 4) zelo drobnozrnate masne glin brez peščene in verjetno z relativno malo meljaste frakcije ter brez kalcijevega karbonata. To jo razlikuje od tipičnega jezerskega sedimenta na Ljubljanskem barju, t. i. jezerske krede. Sklepati je mogoče, da gre izključno za terigen material, ki se je usedal v tedanjem jezeru.

– Sledi do 7 cm debela “prehodna plast” 3 (sl. 5: plast 3) med glino (plast 4) in peskom (plast 2), ki je nastala zaradi gravitacijskih obremenitev na stiku dveh različnih sedimentov. Pesek se je zaradi utekočinjenja (likvifikacije) vtiskal v glino in obratno. To so obremenitvene strukture. Tako v glini opazujemo celo manjše leče peska. Ni mogoče povsem izključiti niti bioturbacijskega nastanka te plasti, torej možnosti, da so opazovane strukture vsaj delno posledica aktivnosti nevretenčarjev.

<sup>14</sup> Vzorci št. 40 (GK y 446821.849, x 92201.424), 41 (GK y 446820.239, x 92199.93) in 42 (GK y 446823.6056, x 992199.099). Koordinate so pobrane na spodnjem robu vzorca (sl. 4).

<sup>15</sup> Opis plasti v nadaljevanju poglavja povzet po: *Poročilo o pregledu vzorcev sedimentov, odvzetih ob rimski tovorni ladji na Vrhniki (oktober 2012)* avtorja Tomaža Verbiča iz družbe Arhej, d. o. o., ki je pregled in testiranja opravil donatorsko.



Sl. 4: Sinja Gorica. Lega ladje v strugi Ljublanice (glej sl. 1: d) in mesta odvzetih vzorcev za sedimentološko analizo: **A** – tloris; **B** – presek a–a”; **C** – bližnji pogled na mesta vzorčevanja. OSL označuje lego vzorca sedimenta iz dna struge, ki je bil leta 2009 odvzet za datacijo z metodo optične stimulirane luminiscence.

Fig. 4: Sinja Gorica. Position of the barge in the Ljublanica riverbed (see Fig. 1: d) and of the samples taken for sediment analysis. **A** – ground plan; **B** – cross section a–a”; **C** – detailed view of the sampled area. OSL marks the position of the sample taken from the riverbed in 2009 for dating with the optical stimulated luminescence method.

– Pesek – plast 2, debela je okoli 26 cm – je aluvialni sediment, odložen diskordantno, s stratigrafskim hiatusom na glino. Posamezni manjši vključki gline v drobn- do srednjzrnatem pesku so najverjetneje posledica s tekočo vodo premeščenih klastov (sl. 5: plast 2).

– Zgornjo plast 1, debelo okoli 80 cm (vzorca 41 in 42; sl. 5: plast 1), sestavlja debelozrnat pesek brez vidnih sedimentnih struktur z obilico fragmentov lesa. Pesek je nastal v aluvialnem sedimentnem okolju, torej kot naplavina. Litološka pestrost zrn v pesku pa nakazuje njegov izvor v dolini Podlipščiće.

Ladja ob ohranjenem boku ni bila povsem odkopana zaradi zelo slabe ohranjenosti lesa. Sediment, ki prekriva ladjo v neočiščenih delih proti brežini (glej sl. 10: sediment 2), ustreza zgornjemu opisu, medtem ko je bilo mogoče v sedimentu v notranjem delu ladje tik ob ohranjenem boku (glej sl. 10: sediment 1) opazovati močno povečano vsebnost fragmentov lesa in vejevja, ob kopanju in čiščenju pa je bil tudi precej bolj kompakten.

Omeniti je treba še vzorec gline za OSL-datacijo,<sup>16</sup> ki je bil pobran med dokumentiranjem leta 2009 v neposredni bližini ladje (sl. 4: OSL). Rezultat datacije je pokazal starost glinenih plasti dna Ljublanice na nadmorski višini 283,20 m med  $17.000 \pm 1.600$  in  $9.000 \pm 1.300$  BP.<sup>17</sup> Višinska razlika okoli 60 cm med višino vzorca OSL in vzorca 40 (sl. 4) kaže na verjetno hidrogeološko erozijsko poglobljanje dna v zadnjih tisočletjih.

Ladja torej leži na glineni plasti 4, obdana pa je s plastmi peščenih aluvialnih zasipov (plasti 2–1), katerih izvor je najverjetneje v dolini Podlipščiće.

Verbič, Erič

### 3. DOKUMENTIRANJE

Fotogrametrija ima v podvodni arheologiji sicer dolgo zgodovino,<sup>18</sup> tudi na vzhodni obali Jadrana,<sup>19</sup> vendar so za njene začetke veljale podobne omejitve kot za fotogrametrijo na suhem. To je bil zelo zamuden postopek fotografiranja pod vodo, da bi bile fotografije čim bolj poravnane, nato pa je sledilo iskanje korespondenčnih točk med stereo pari fotografij v laboratoriju. Zato so bili fotogrametrični

<sup>16</sup> OSL = Optično stimulirana luminiscenca; Gaspari, Erič, Odar 2012, 236.

<sup>17</sup> Gaspari, Erič, Odar 2012, 236.

<sup>18</sup> Drap et al. 2013.

<sup>19</sup> Erič et al. 2013.

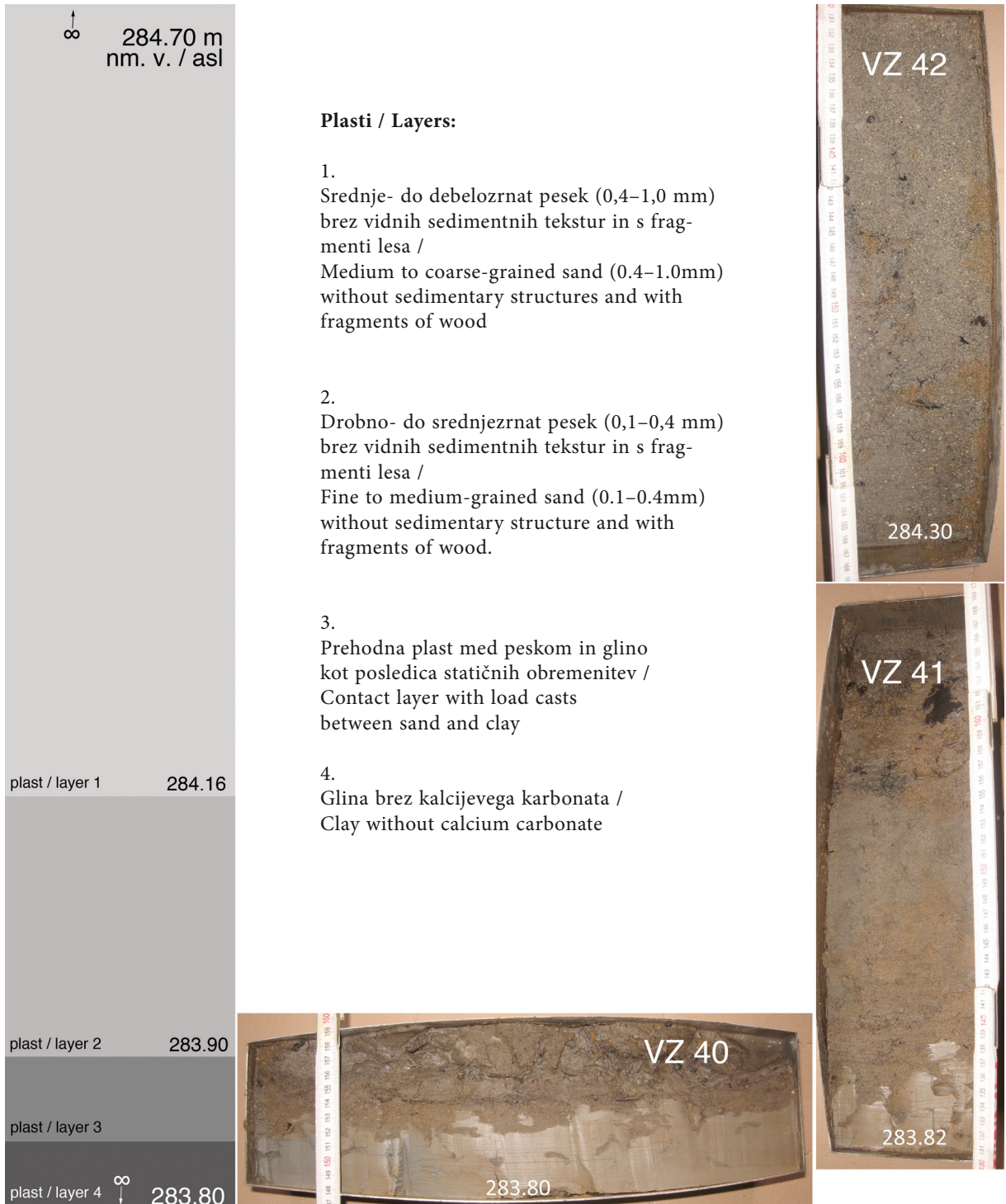

Sl. 5: Ljubljana pri Sinji Gorici. Stratigrafija plasti ob ladji in pod njo.  
Fig. 5: The Ljubljana at Sinja Gorica. Stratigraphy of layers beside and under the barge (VZ = sample).



zajemi podatkov pod vodo v preteklosti dražji od ročnega oziroma klasičnega dokumentiranja, tako zaradi obsežnega dela pod vodo kot tudi zaradi zelo zamudnega laboratorijskega dela.

Zaradi potrebnega časa in stroškov meritve niso bile nikoli tako goste oziroma številne, da bi lahko že na podlagi meritev ustvarili terensko dokumentacijo in risbe predmetov, ki bi nadomestile klasične postopke dokumentiranja. Računalniško zasnovane metode dajejo tako goste podatke, da je mogoče govoriti o globinski ali 3R-sliki, ki je sestavljena iz gostega oblaka točk, vsaka od teh točk pa ima vse tri prostorske koordinate. Iz skupin namensko posnetih slik iz različnih zornih kotov je tako mogoče sestaviti bolj ali manj popolne 3R-modele. Pri fotografiranju odpadejo omejitve pri nameščanju kamer, zato je mogoče snemati iz roke brez dodatne opreme. Posneti je treba le dovolj veliko množico slik, ki se paroma prekrivajo med seboj za okoli 75 %. Danes pa se že uveljavljajo programska orodja, ki omogočajo sestavljanje 3R-modelov kar iz video zapisov. Enostavna uporaba v primerjavi s klasičnimi pristopi k nekaterim postopkom dokumentiranja je odlika, zaradi katere se tak pristop vse pogosteje uporablja tudi pri arheoloških raziskavah.

Danes je fotogrametrični zajem podatkov pod vodo ne le natančnejši in hitrejši od klasičnega dokumentiranja, ampak zaradi močno skrajšanega časa, potrebnega za zajem podatkov, hitrejši, cenejši in s tem varnejši. Ta hip je med vsemi metodami 3R-dokumentiranja najdišč pod vodo najbolj uporabna fotogrametrija.

Pri dokumentiranju rimske tovarne ladje je bila prvič v Sloveniji uporabljena metodologija namenskega fotogrametričnega snemanja za izdelavo 3R-modela.<sup>20</sup> Programsko fotogrametrija temelji na samodejni večplastni analizi digitalnih fotografij. Obsega identifikacijo diskriminativnih slikovnih značilnic na posameznih fotografijah, iskanje stabilnih ujemanj med značilnicami na različnih posnetkih, samodejno kalibracijo sistema fotografij, izdelavo gostega oblaka 3R-točk, ki najbolje opisuje vso informacijo, razpoložljivo na vhodnih slikah, ter izdelavo regularne teksturirane trikotniške mreže.

S fotogrametrijo pridobljeni 3R-modeli (sl. 6) so se izkazali za zelo natančne, reprezentativne ter analitično uporabne. Za ročno dokumentiranje

okoli 8 m<sup>2</sup> velike površine plovila bi po oceni potrebovali najmanj 25 potapljaških ur. Za namenska fotografiranja ladje v 4 različnih stanjih raziskav pa so bile potrebne le 3 potapljaške ure. Iz skupin fotografij so bili sestavljeni trije 3R-modeli, primerjalna analiza med dvema (sl. 7), ki so jo opravili sodelavci Laboratorija za računalniški vid Fakultete za računalništvo in informatiko Univerze v Ljubljani, pa potrjuje izjemno natančno dokumentiranje. Sicer je o natančnosti mogoče sklepati tudi iz posredno, med pripravo slikovne dokumentacije dobljenih dokazov. Za potrebe preverjanja procesov dokumentiranja so bile opravljene tudi meritve z geodetskimi instrumentom.

Dobljeni podatki so, ob atraktivnih možnostih ogleda virtualnega 3R-modela, širše uporabni. V nasprotju z 2R-fotografijo, ki nespremenljivo določa smer in kot pogleda, ter interpretirano 2R tlorisno dokumentacijo omogoča 3R-model simuliran virtualen pogled v dokumentirane površine ali predmete, ki jih je mogoče zelo natančno proučevati.<sup>21</sup> Pomembnejše je, da so zaradi morfoloških značilnosti 3R-oblakov prostorsko umeščenih točk, ki so absolutni posnetek trenutnega stanja, povsem odprte možnosti nadaljnjih analiz 3R-modela. To je še zlasti pomembno zato, ker je proučevanje arheološkega najdišča omejeno na čas terenskih raziskav, kasneje pa je zavarovano *in situ* in težko dostopno, najpogosteje pa uničeno. Sistematično in načrtno je mogoče proučevati, segmentirati ali klasificirati izbrane površine na 3R-modelu. Z avtomatiziranim iskanjem in analiziranjem površin je mogoče na modelu poiskati značilne elemente, ki bi sicer lahko bili zaradi omejenega časa v naravnem okolju spregledani. Pomembna pa je tudi verjetna arhivska trajnost digitalnega arheološkega dokumentarnega gradiva kot podlaga za proučevanje, interpretacijo in promocijo.

Solina, Erič

#### 4. DATACIJA, VRSTE LESA IN OHRANJENOST

##### Radiometrična datacija

Ob odkritju ladje je bil odvzet vzorec lesa iz talne platice (BP 2; sl. 8: AMS) za radiometrično datiranje z metodo AMS <sup>14</sup>C.<sup>22</sup> Prva datacija, ki

<sup>20</sup> Namenska snemanja je opravil Rok Kovačič (Golden Light Photography), 3R-model pa je izdelal Gregor Berginc (Xlab Research, 3dimenzija) s pomočjo domačega programskega orodja Mementify©PHOV (<http://mementify.com, http://phov.eu>).

<sup>21</sup> Erič et al. 2013; Stopinšek et al. 2013.

<sup>22</sup> Erič, Gaspari 2009; Gaspari, Erič 2012.

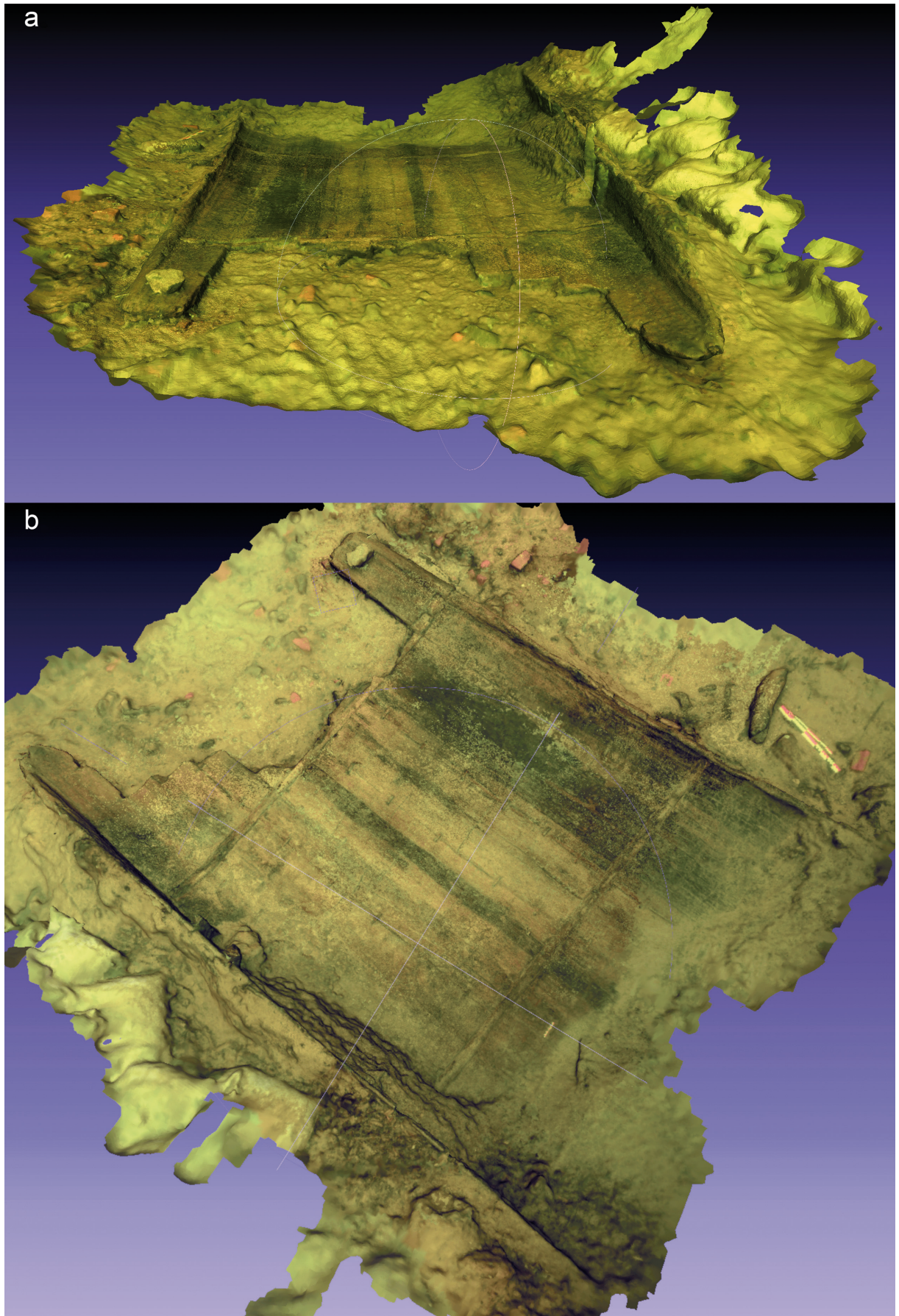

je pokazala starost  $2040 \pm 40$  BP (Beta - 249390), je bila opravljena v laboratoriju Beta Analytic Inc. v Miamiju. Druga, ponovljena datacija lesa iz istega vzorca je bila opravljena v laboratoriju Radiocarbon Accelerator Unit Univerze v Oxfordu in je pokazala starost  $2143 \pm 26$  BP (OxA - 19598).

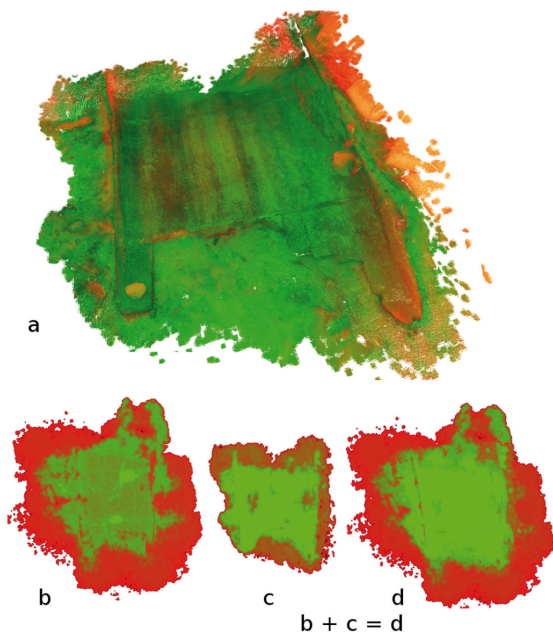

Sl. 7: Ladja iz Sinje Gorice. Primerjava dveh različnih fotogrametričnih rekonstrukcij. Seti fotografij za 3R-modela so bili posneti 13. in 15. oktobra 2012. **a** – Popolno prekrivanje morfologije dveh modelov (zeleno); zanemarljiva odstopanja (oranžni odtenki) so morda lahko povezana tudi s premiki konstrukcije. **b, c, d** – Zelo dobro prekrivanje modelov (zeleno).

Fig. 7: Barge from Sinja Gorica. Comparison of two photogrammetric reconstructions. Sets of photographs for the 3D model were taken on 13 and 15 October 2012. **a** – Complete correspondence of the morphology of both models (green); negligible deviations possibly related to the movement of the barge construction (orange hues). **b, c, d** – Very good correspondence of both models (green). (Primerjalna analiza / Comparative analysis: M. Pugelj; foto / photo: R. Kovačič; 3R- / 3D model: G. Berginc; procesirano z / processed with Mementify©PHOV)

Sl. 6: Ladja iz Ljublanice pri Sinji Gorici. 3R-model: **a** – v preseku, pogled proti jugovzhodu; **b** – v perspektivnem tlorisu, usmerjeno proti severu.

Fig. 6: Barge from Sinja Gorica. 3D model: **a** – cross section, view towards the south-east; **b** – perspective ground plan, towards the northward orientation.

(3R- / 3D model: G. Berginc; foto / photo: R. Kovačič)

Rezultata, kalibrirana s programom Intcal 04,<sup>23</sup> sta pokazala starost 50 pr. n. št.–20 n. št. ( $1\sigma$ ) oz. 110 pr. n. št.–60 n. št. ( $2\sigma$ ) (Beta) in 211–91 pr. n. št. ( $1\sigma$ ) oz. 206–157 pr. n. št. ( $2\sigma$ ) (OxA).

### Identifikacija lesa in dendrokronološko datiranje

Med raziskavo leta 2012 je bilo odvzetih 17 vzorcev lesa iz talnih (BP) in bočnih platic (SP), čolnic (CG), talnih (FT) in bočnih tramičev (ST) ter tesnil (sl. 8). Zaradi ohranjanja lesenih delov so bili odvzeti vzorci manjših velikosti – večinoma bloki, veliki nekaj kubičnih centimetrov – za identifikacijo lesa in osnovne analize.

Za določanje lesnih vrst so bili z vodo prepojeni vzorci globoko zamrznjeni. S skalpelom so bile odrezane 3 po 20  $\mu\text{m}$  debele rezine prečnega, radialnega in tangencialnega prereza lesa. Položene so bile na objektno steklo, potopljene v glicerin in pokrite s krovnim steklom. Tako pripravljene preparate so bili pregledani pod svetlobnim mikroskopom Nikon Eclipse E800. Identifikacija lesa je bila opravljena s pomočjo ključev za identifikacijo lesa evropskih iglavcev in listavcev.<sup>24</sup>

Identifikacija lesa je pokazala, da so bile talne platice (BP 1–BP 5), bočna platica (SP1) in čolnici (CG 1 in CG 2) iz bukovega lesa (*Fagus sylvatica*), ki ima največji volumski delež lesa v ladji (sl. 8). Samo manjši elementi so bili narejeni iz drugih vrst lesa. Talna tramiča sta iz lesa jesena (*Fraxinus excelsior*) in bresta (*Ulmus sp.*), bočna tramiča pa iz jelke (*Abies alba*) in jelše (*Alnus glutinosa*).

Od 14 vzorcev<sup>25</sup> sta bila le dva dovolj velika in primerna za dendrokronološko analizo. To sta bila vzorca 23 iz talne platice BP 2 in 34 iz bočne platice SP 1 (sl. 8). Les za dendrokronološko raziskavo je bil globoko zamrznjen, prečne površine lesa pa so bile zglajene s skalpelom. Širine branik so bile izmerjene s pomočjo premične mizice LINTAB, stereo mikroskopa Olympus in programa TSAP-Win.

Platica BP 2 je imela 83 branik, SP 1 pa samo 40. Zaporedja širin branik so bila v odvisnosti od časa vizualno sinhronizirana, sestavljena je bila kronologija plovila in primerjana z referenčnimi

<sup>23</sup> Reimer et al. 2009.

<sup>24</sup> Schweingruber 1990; Schoch, Schweingruber, Kienast 2004.

<sup>25</sup> Vzorci 19, 26 in 28 so bili iz istih konstrukcijskih elementov.

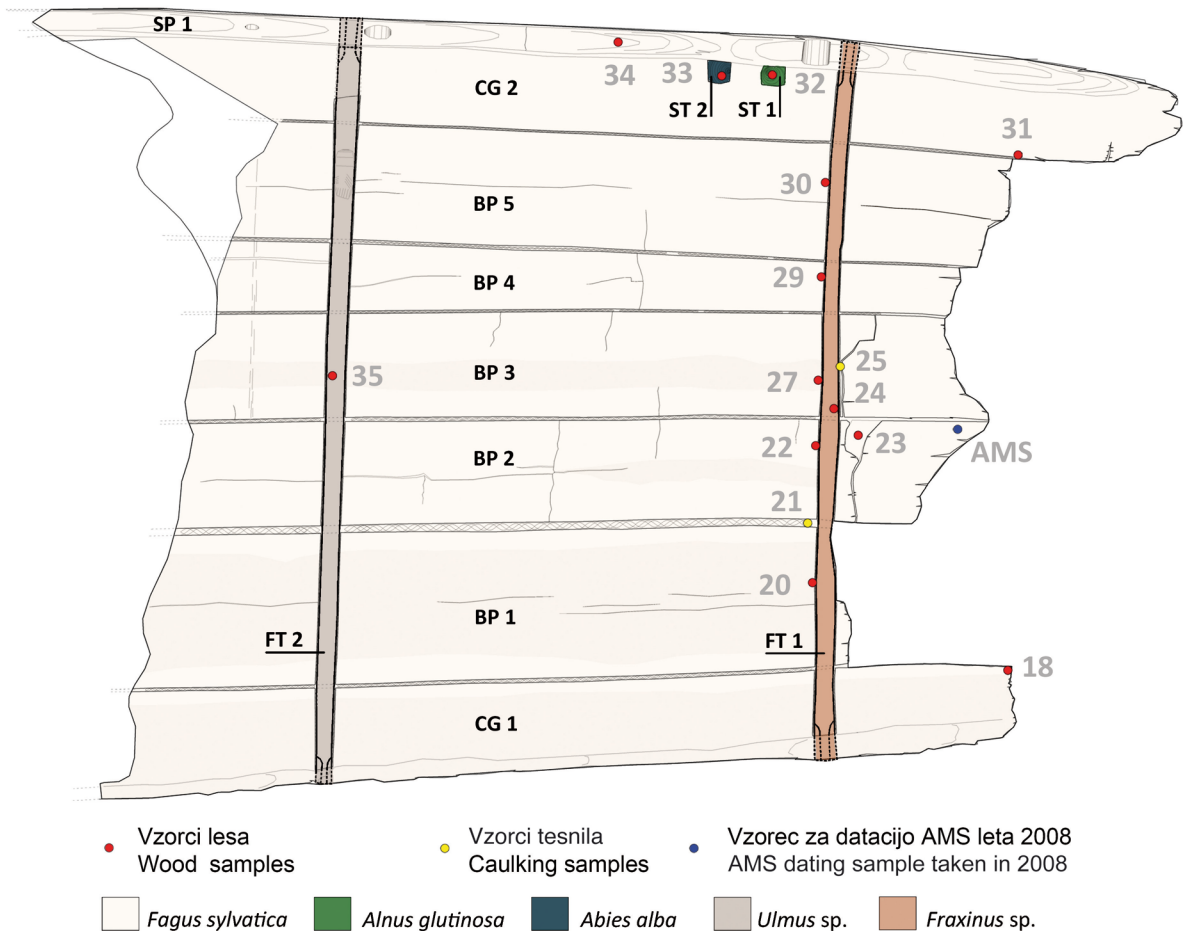

Sl. 8: Ladja iz Sinje Gorice. Oznake odkritih lesenih konstrukcijskih elementov: CG – čolnici, BP – talne platice, SP – bočna platica, FT – talna tramiča, ST – bočna tramiča. Mesta odvzetih vzorcev lesa, vzorcev tesnila in vzorca za radiometrično datacijo AMS (barvne točke). Vzorca za dendrokronologijo sta bila odvzeta iz talne platice BP 2 (vzorec 23) in bočne platice SP 1 (vzorec 34).

Fig. 8: Barge from Sinja Gorica. Construction elements: CG – chine-girders, BP – bottom planks, SP – side planks, FT – floor-timbers, ST – side timbers. Positions of the wood and caulking samples, for AMS dating (coloured dots) and dendrochronological analyses, the latter samples taken from Bottom Plank 2 (Sample 23) and Side Plank 1 (Sample 34). (Glej / see Čufar, Merela, Erič 2014)

kronologijami Oddelka za lesarstvo.<sup>26</sup> Datiranje z več referenčnimi kronologijami objektov iz rimske dobe v Ljubljani (najdišče Tribuna) in na Vrhniki (najdišči Dolge njive in Breg), je bilo uspešno, ter je pokazalo leto 3 n. št. kot leto nastanka zunanje branike. Najboljše ujemanje je bilo dobljeno pri datiranju z bukovo kronologijo branik z najdišča Tribuna TRIFA904, ki ima časovni razpon od leta 176 pr. n. št. do leta 2 n. št. Datiranje je bilo potrjeno z naslednjimi statističnimi parametri: t- vrednost po Baillie-Pilcherju TVBP = 6,0, ko-

eficient skladnosti (*Gleichläufigkeit*) GLK = 67 \*\*\* in prekrivanje OVL = 83 let. Vrednosti kazalnikov datiranja so visoke in statistično značilne, kar je mogoče pripisati dejstvu, da kronologija TRIFA904 temelji na vzorcih lesa bukve, ki najverjetneje izvirajo iz gozdov v okolici Vrhnike.

Branika z datumom leto 3 n. št. je na zunanjem delu platice BP 2, vendar na podlagi te datacije še ni mogoče določiti natančnega leta izdelave ladje.<sup>27</sup> Če je bila datirana branika tik pod skorjo, bi ugotovljeno leto 3 pomenilo zadnje leto življenja

<sup>26</sup> Čufar 2010.

<sup>27</sup> Haneca, Čufar, Beeckman 2009.

drevesa, ki so ga posekali za nadaljnjo uporabo. V tem primeru bi bila ladja najverjetneje narejena leta 3 ali 4. Po videzu vzorca iz talne platice žal ni mogoče potrditi, ali je datirana branika bila v drevesu tik pod skorjo oz. koliko branik je bilo pri obdelavi lesa odstranjenih. Datum 3 n. št. je zato treba obravnavati kot *terminus post quem*, torej leto, po katerem je bilo drevo za izdelavo plovila posekano. Na podlagi rezultatov je mogoče sklepati, da je bila ladja najverjetneje izdelana v desetletju po letu 3 n. št.

Dendrokronološka analiza in izbor lesnih vrst nakazuje, da je bil za izdelavo ladje uporabljen les iz bližnje okolice. Les bukve, jelke in bresta je uspeval v gozdovih dinarskega Krasa v zaledju Vrhnik oz. na južnem robu Ljubljanskega barja. Nasprotno sta jelša in jesen, tako kot danes, uspevala predvsem na poplavni ravnici Ljubljanskega barja in na bregovih Ljublanice.

Les bukve (*Fagus sylvatica*) ima med domačimi lesnimi vrstami precej visoko gostoto (srednja gostota absolutno suhega lesa  $r_0$  je  $680 \text{ kg/m}^3$ ) in dobre mehanske lastnosti. To pomeni, da je les trden in trd, vendar ima nizko trajnost, saj ga uvrščamo v najnižji razred odpornosti lesa (5 – zelo občutljiv).<sup>28</sup>

Bukovina ni tipična vrsta lesa za izdelavo plovil, čeprav je bila občasno uporabljena predvsem za manjše sestavne dele. Plovila, v celoti narejena iz bukovine, pa so izjemno redka.<sup>29</sup> Uporabo bukovine ovira predvsem nizka odpornost lesa, čeprav je z vodo napojen les praviloma varen pred okužbo z insekti in glivami.<sup>30</sup> Po gostoti in mehanskih lastnostih je bukovina primerljiva s hrastovino, glavna razlika med vrstama pa je v tem, da ima hrastovina odporno jedrovino (razred odpornosti 2 – odporen).<sup>31</sup> Glavni vrsti hrasta pri nas, graden in dob (*Quercus petraea* in *Quercus robur*), imata srednjo gostoto  $r_0$   $650 \text{ kg/m}^3$ .<sup>32</sup> Druge uporabljene lesne vrste imajo naslednje lastnosti: jesen – gostota  $650 \text{ kg/m}^3$ , razred odpornosti 5); brest – gostota  $640 \text{ kg/m}^3$ , razred odpornosti 4; jelša (*Alnus glutinosa*) – gostota  $510 \text{ kg/m}^3$ , razred odpornosti 5; in jelka (*Abies alba*) – gostota  $410 \text{ kg/m}^3$ , razred odpornosti 4.<sup>33</sup>

Od naštetih vrst je jelka edini iglavec. Les jelke in jelše ima nižjo gostoto in je manj trden in trd od lesa jesena, bresta in bukve.

Na podlagi zgoraj navedenega je mogoče sklepati, da je bila bukovina najverjetneje izbrana za gradnjo plovila predvsem zaradi razpoložljivosti. Prav tako je mogoče sklepati, da je bilo v rimskem času, podobno kot danes, povpraševanje po hrastovini veliko in je presegalo ponudbo. Količine hrastovine so bile omejene zaradi majhnega deleža hrasta v bližnjih gozdovih. Hrastovino so zaradi njene trajne jedrovine potrebovali za številne namene, še posebej za zunanje konstrukcije in za plovila.<sup>34</sup> V primeru plovila iz Ljublanice so posegli po dostopni bukovini, kar je omogočilo izdelavo težkega in robustnega plovila, primerne tudi za prevažanje težjega tovora.

### Ohranjenost lesa

Ohranjenost oz. degradacija lesa je bila ocenjena z opazovanjem pod mikroskopom in z določitvijo napojitvene vlažnosti lesa ( $u_{max}$ ), ki temelji na masi vode, preračunani na maso popolnoma suhega lesa.<sup>35</sup>

Napojitvena vlažnost lesa ( $u_{max}$ ) iz ladje je bila 690 %, kar pomeni zelo slabo ohranjen les (sl. 9). To potrjujejo tudi smernice angleške komisije za dediščino (English Heritage) o ravnanju z mokrim lesom, ki pravijo, da je les že zelo razkrojen pri vrednostih  $u_{max}$  nad 150 %.<sup>36</sup> Za primerjavo je dobro vedeti, da je  $u_{max}$  normalne bukovine približno 110 %, bukovina s kolišč na Ljubljanskem barju, stara okoli 4500 let, je imela  $u_{max}$  okoli 800 %, bukov les nekaterih konstrukcijskih elementov rimskih ladij, odkritih v bližini Neaplja, pa okoli 450 %.<sup>38</sup>

Celične stene vlaken v ladijskem lesu so približno petkrat tanjše kot v normalnem lesu, kar je posledica dolgotrajnega delovanja erozivnih bakterij.<sup>39</sup> Mikroskopske preiskave so pokazale tudi, da je delež celuloze v celičnih stenah zmanjšan, delež lignina pa povečan.<sup>40</sup>

Slabo ohranjenost lesa bo treba upoštevati pri pripravi konservatorskega načrta. Največja nevar-

<sup>28</sup> Lesar, Humar, Oven 2008; Čufar et al. 2012.

<sup>29</sup> Radić Rossi, Boetto 2011.

<sup>30</sup> Čufar et al. 2012.

<sup>31</sup> Humar et al. 2008.

<sup>32</sup> Merela, Čufar 2013.

<sup>33</sup> Grosser, Teetz 1987; Lesar, Humar, Oven 2008.

<sup>34</sup> Glej Gaspari 1998a.

<sup>35</sup> Čufar et al. 2008; Čufar, Merela, Erič 2014.

<sup>36</sup> Brunning, Watson 2010.

<sup>37</sup> Čufar, Tišler, Gorišek 2002.

<sup>38</sup> Capretti et al. 2008.

<sup>39</sup> Björdal Gjelstrup 2012; Singh 2012.

<sup>40</sup> Čufar, Merela, Erič 2014.

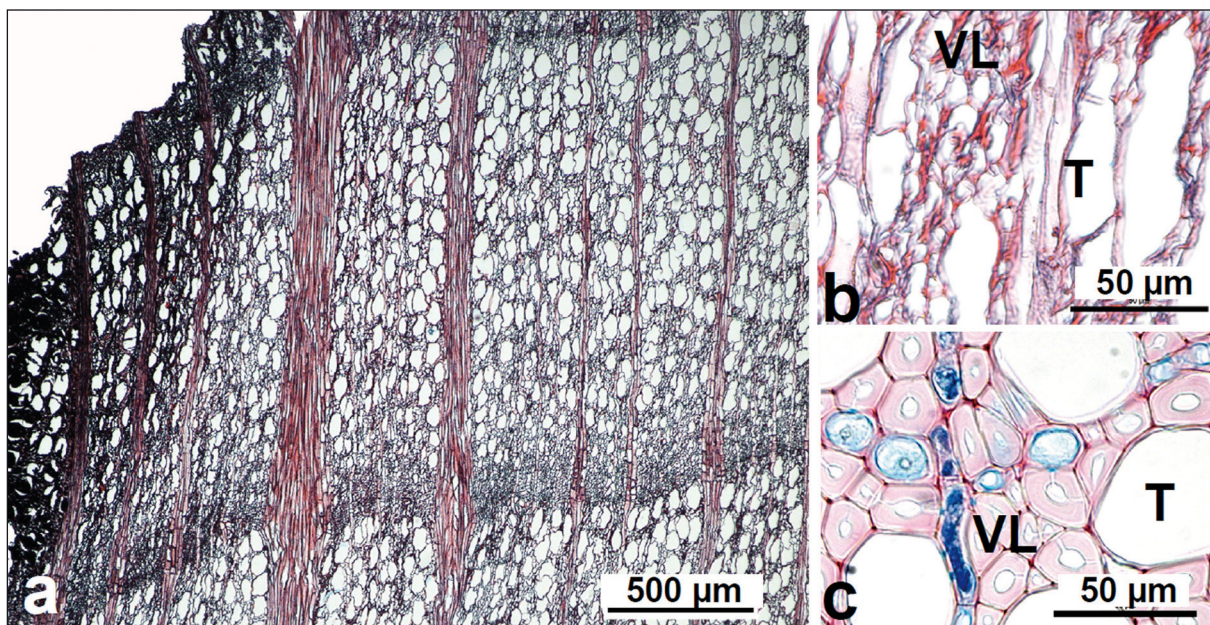

Sl. 9: Ladja iz Sinje Gorice. Prečni prerez lesa bukve (*Fagus sylvatica*) iz ladje (a, b) in recentnega lesa (c). Celične stene vlaken (VL) so v lesu ladje tanjše kot v normalnem lesu, vlakna in traheje (T) pa so delno kolabirana.

Fig. 9: Barge from Sinja Gorica. Cross sections of the beech (*Fagus sylvatica*) wood of the vessel (a, b) and of recent wood (c). Cellular walls of wood fibres (VL) from the barge are thinner than in normal wood, fibres and trachea (T) are partially collapsed.

(Foto / Photo: M. Merela)

nost bi bila izpostavitve lesa sušenju na zraku. V tem primeru bi, tudi ob kratkotrajnem sušenju, hitro nastale razpoke, les bi se krčil, s tem bi se popolnoma izgubila oblika in močno deformirala ladijska konstrukcija. Delno osušen les bi doživel še biološki razkroj, kar bi v kratkem času vodilo do popolnega uničenja ladje. Za ohranitev ladje bi sicer prišli v poštev tudi postopki konzerviranja z enim od splošno uporabljenih konsolidacijskih sredstev,<sup>41</sup> vendar kljub napredku v razvoju konzerviranja mokrega lesa še vedno niso odkrili metodologije za dolgotrajnejšo zaščito tovrstne dediščine,<sup>42</sup> postopki pa so tudi zamudni in dragi. Tako se, ob upoštevanju razmerij med pomenom, zanesljivostjo postopkov in ceno, kot sprejemljiva ponuja zaščita *in situ*.

Čufar, Erič

## 5. LADIJSKA ZGRADBA

Zaradi omejitev je bila ladja dokumentirana v dolžini 4,2 m. Izpostavljeni del ladje, ki sega izpod peščenega sedimenta v strugo, je bil ob odkritju odlomljen, v treh letih od zadnjega ogleda pa je vodni tok ladjo dodatno poškodoval in odlomil dele dveh talnih platic (BP 2 in BP 3). V delu, kjer je ladja poškodovana, je široka 2,47 m, v delu, ki izginja pod sediment, pa 2,88 m (sl. 10).

### Konstrukcijski elementi

Na odkritih delih plovila so bili dokumentirani dve čolnici, pet talnih platic, ena bočna platica, dva vezna talna tramiča in dva bočna tramiča (sl. 10).

#### Čolnici

**CG 1:** Čolnica iz bukovine je bila zaradi lege ladje v brežini ter zaradi turbulentnih in erozijskih delovanj bolj izpostavljena propadanju. Dokumentirana ohranjena dolžina je 3,3 m, na v strugo

<sup>41</sup> V uporabi so predvsem konservatorski postopki prepažanja s polietilenglikolom, melaminom ali saharozo.

<sup>42</sup> Glej Christensen, Kutzke, Hansen. 2012; Gregory, Jensen, Strætkvern 2012; Hocker, Almkvist, Sahlstedt 2012.

izpostavljenem delu je široka 31 cm, v delu, ki gre v sedimente, pa 37 cm in se razširi za faktor 1,19. Zaradi poškodb in zgolj manj ohranjenega dela v prehodu iz dna v bok višine ni bilo mogoče izmeriti. Debelina v stiku s talno platico BP 1 je 5 cm, v kolenu pa 8 cm. Debelina v kotu 45° v kolenu je 10 cm. Čolnici je bilo zaradi okoliščin vstopanja pod sedimente v brežini mogoče po robu slediti še nekaj manj kot 3 m, torej v skupni dolžini okoli 6,3 m. Les čolnice je v širini okoli 5 do 6 cm ob stiku z BP 1 svetleje obarvan kot preostali del (*sl. 6: a, levo; sl. 10: C*).

**CG 2:** Bolje ohranjena dokumentirana čolnica iz bukovine je dolga 4,15 m, široka 32 cm v odlomljenem delu in 38 cm pri sedimentih (faktor 1,18) ter visoka 34 cm. V stiku s talno platico BP 5 je debela 5 cm, v prehodu iz dna v bok 9 cm in 6 cm v stiku z bočno platico SP 1. Kot prehoda iz dna ladje v bok je med 92° in 94°. Za krivuljo bočnega dela čolnice CG 2 in bočne platice SP 1, ki jo je bilo mogoče zaznati na 3R-modelu in ima 37 m premera (glej *sl. 25: a*), za zdaj ni mogoče povsem z gotovostjo trditi, da je bilo to delo ladijskih tesarjev ali pa gre morda samo za abrazirane dele kot posledice rečne erozije. Razdalja, na kateri je bila krivulja zaznana, je vendarle zelo kratka, rezultat pa tako ni povsem gotov (*sl. 6: a, desno; sl. 10: B*).

### *Bočna in talne platice*

V delu, ki je izpostavljen v rečni tok Ljublanice, so, tako kot tudi čolnici, vse talne platice polomljene. Na nobeni od teh ni bilo opaziti obdelav, ki bi lahko kazale na morebitne stike z drugimi talnimi platicami ali dodatno notranjo konstrukcijo, razen dveh talnih tramičev. Prav tako vse odkrite (bočna in talne) platice izginjajo pod sediment v brežini (*sl. 6: a, desno; sl. 10: A,B*). Vse platice se spajajo z ravnimi stiki.

**SP 1:** Na ladji je bila raziskana samo ena bočna platica iz bukovega lesa v dolžini 2,5 m, ki je na stiku s čolnico CG 2 debela 6 cm. Platice je močno abrazirana in uničena v izpostavljenem delu. Proti delu, ki izginja v sedimente, se postopoma širi in je visoka 30 cm.

**BP 1:** Talna platice iz bukovega lesa je pri talnem tramiču FT 1 odlomljena in široka 50 cm, v delu, ki gre pod sediment, pa 54 cm, dolga je 2,5 m, debela pa med 5 in 5,5 cm. Na obeh straneh platice (na stiku z CG 1 in BP 2) je les svetleje obarvan v širini od 5 do 12 cm.

**BP 2:** Ob odkritju ladje leta 2008 je bila talna platice iz bukovega lesa ohranjena v dolžini okoli 3 m, v zadnjih letih pa je odplavilo približno 40 cm platice (enako velja tudi za platico BP 3). Ob dokumentiranju oktobra 2012 je bila izmerjena dolžina 2,55 m, širina v odlomljenem delu 36 cm in pri sedimentih 37 cm, debelina 5 cm. Tudi les te platice je bil v manjšem delu ob talnem tramiču (FT 1) temneje obarvan. Iz te platice so bili odvzeti vzorci za radiometrične (*sl. 8: AMS*) z rezultatom 50 pr. n. št. do 20 n. št. in dendrokronološko datacijo (*sl. 8: vzorec št. 23*), ki je pokazala na leto 3 n. št.

**BP 3:** Ohranjena dolžina platice iz bukovega lesa je 2,40 m (ob odkritju okoli 2,80 m), širina v ožjem delu je 35 cm, v širšem pa 38 cm, debelina 5 cm. Les te platice je v osrednjem delu temneje obarvan v širini okoli 10 cm.

**BP 4:** Ta bukova platice je od vseh najožja, in sicer 16 cm v izpostavljenem delu in 25 cm pri sedimentih. Dokumentirana ohranjena dolžina platice je 2,75 m, debelina pa okoli 5 cm. Les platice ni temneje obarvan.

**BP 5:** Najdaljša raziskana platice iz bukovega lesa je dolga 2,85 m, široka od 39 do 41 cm, debelina 5 cm. Les ni temneje obarvan.

Vse talne platice se rahlo širijo od poškodovanega dela proti sedimentu za faktor približno 1,06, izrazito pa je obtesana platice BP 4, ki se razširi kar za faktor 1,56.

### *Talna tramiča*

Na ladji sta bila od notranje konstrukcijske opreme – kolena, rebra in talni tramiči – opažena samo dva talna tramiča (*sl. 8; 10; 11*) na razdalji 1,8 m.

Prvi (**FT 1**) je narejen iz tanjšega jesenovega debela premera od 6,5 do 7,2 cm, dolžine 2,6 m, drugi (**FT 2**) pa iz brestovega debela premera 6,5 do 8 cm, dolžine 2,77 m. Oba sta vzdolžno razpolovljena ter ob straneh rahlo obtesana, tako da je njuna debelina od 3 do 4 cm. V konstrukcijsko školjko iz čolnic in talnih platic sta bila vpeta tako, da sta z ravno površino "legla" v prečno iztesan utor, globok do 2,5 cm, v talne platice in čolnici. Za vpenjanje talnih tramičev (oba tramiča sta bila tesarsko enako nameščena) sta bili v čolnici izdolbeni pravokotni luknji, ki sta jih prebili na zunanjo stran. Talni tramič je bil v prehodu skozi čolnico šesterokotno obtesan, z zunanje strani pa so bili na štirih straneh zabiti leseni klini (*sl. 12: b*), namenjeni čvrstemu stiku in tesnjenju med

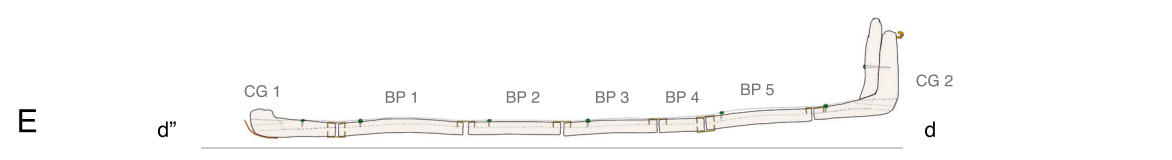
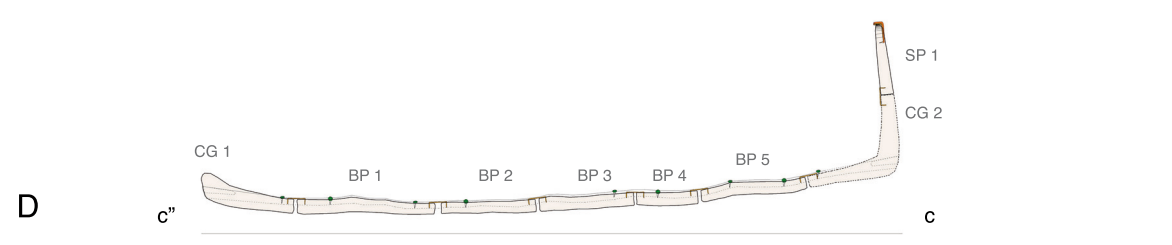
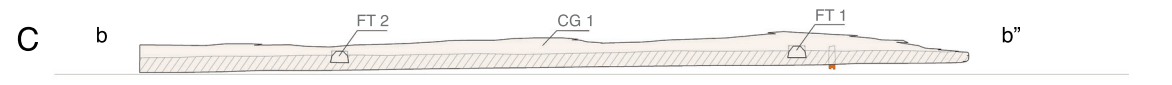
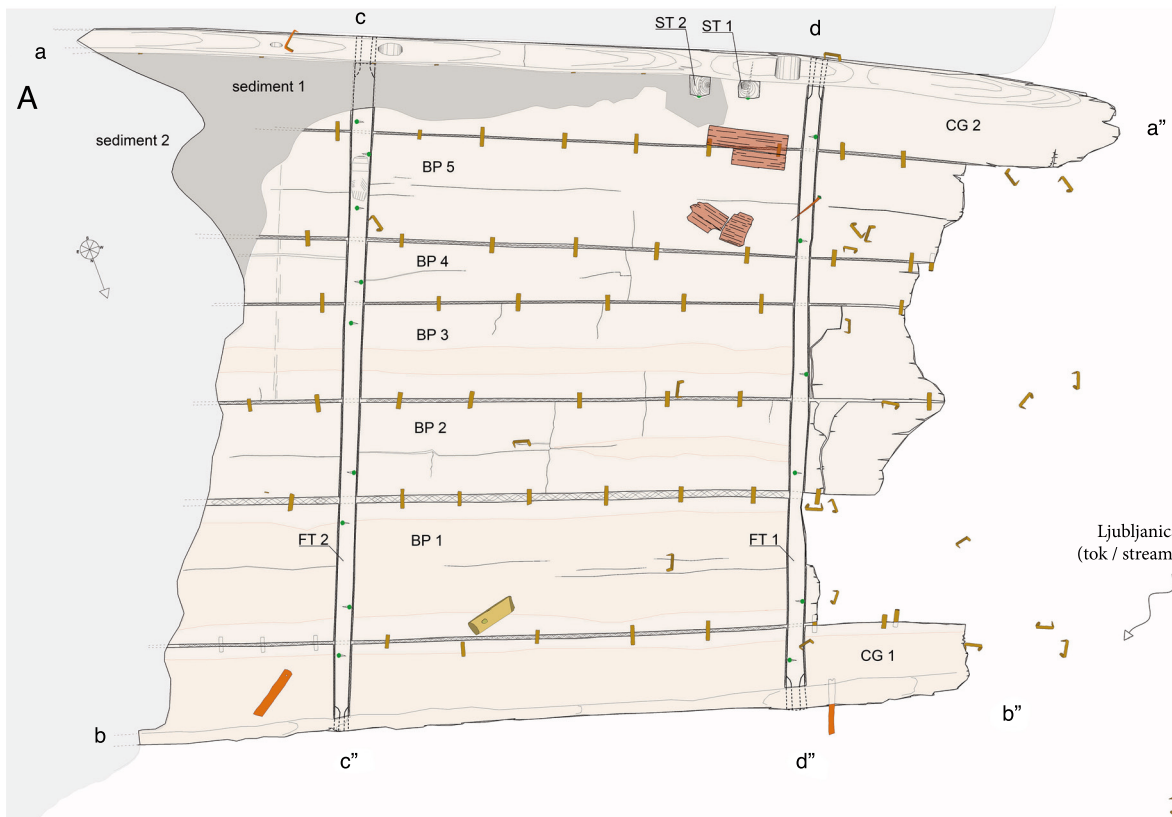
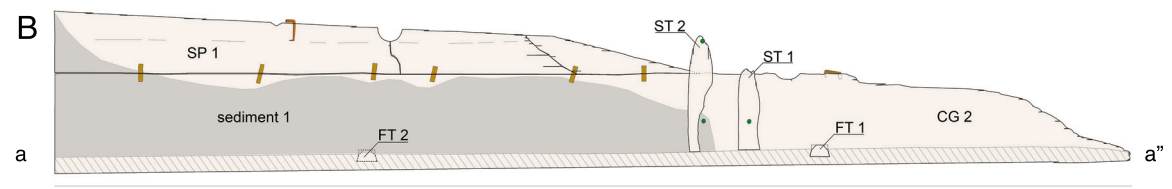



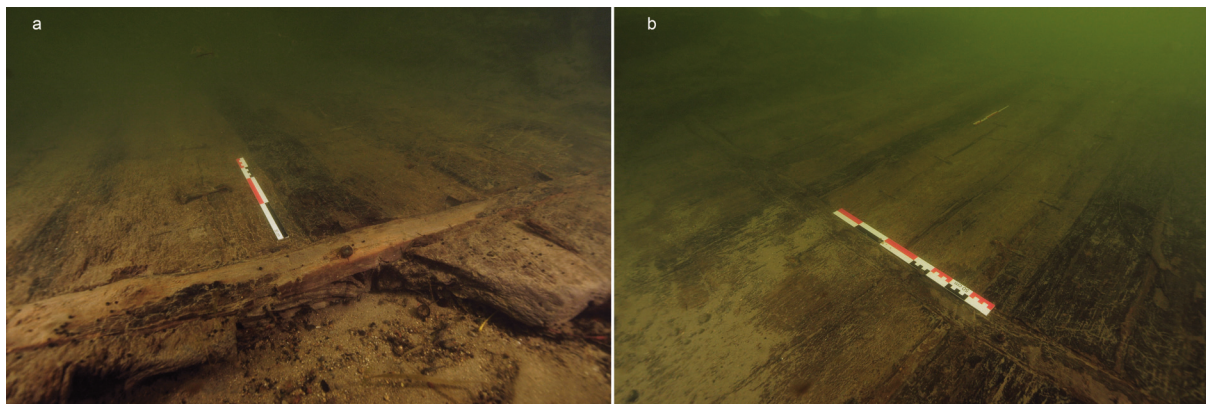

Sl. 11: Ladja iz Sinje Gorice. Talna tramiča: **a** – FT 1, pogled proti jugovzhodu; **b** – FT 2, pogled proti zahodu.  
 Fig. 11: Barge from Sinja Gorica. Floor-timbers: **a** – FT 1, view towards the south-east. **b** – FT 2, view towards the west.  
 (Foto / Photo: R. Kovačič)

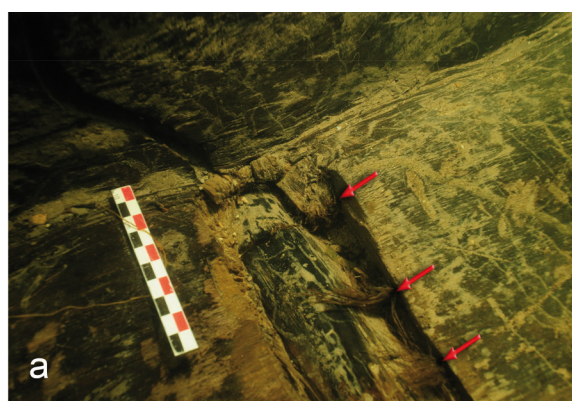

Sl. 12: Ladja iz Sinje Gorice. Vpenjanje talnega tramiča v ladijsko konstrukcijo. **a** – Preboj talnega tramiča (FT 1) skozi čolnico (CG 2) iz notranje strani z opaženimi tesnili iz rastlinskih vlaken (puščice). **b** – Preboj talnega tramiča (FT 1) skozi čolnico (CG 1) z zunanje strani in tehnika spajanja s pomočjo klinov z zunanje strani (puščice).

Fig. 12: Barge from Sinja Gorica. Inserting the floor-timber into the barge's construction. **a** – Floor-timber 1 inserted through Chine-girder 2 from the interior, with caulking of plant fibres (arrows). **b** – Floor-timber 1 inserted through Chine-girder 1 from the exterior and kept in place with wedges from the exterior (arrows).

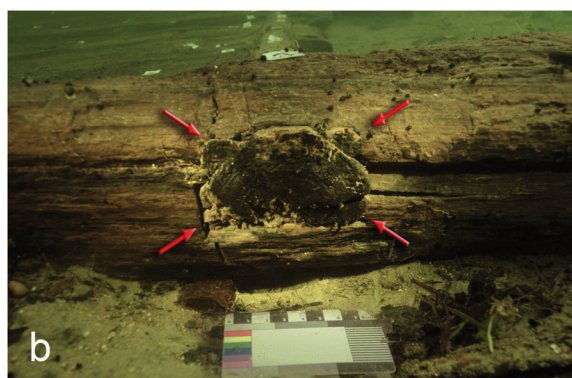

←

Sl. 10: Načrt ladje iz Sinje Gorice. **A** – tloris; **B** – vzdolžni presek iz notranje strani; **C** – vzdolžni presek iz zunanje strani; **D, E** – prečna preseka. Deli ladje: talna platica (BP), talni tramič (FT), čolnica (CG), bočna platica (SP), bočni tramič (ST) in neposredno z ladjo povezani elementi (spojke: oranžno; žebliji: zeleno) ter dve deščici.

Fig. 10: Construction plan of the barge from Sinja Gorica. **A** – ground plan; **B** – longitudinal cross section, from the interior; **C** – longitudinal cross section, from the exterior; **D, E** – transverse cross sections. Construction elements of the barge: bottom plank (BP), floor-timber (FT), chine-girder (CG), side planks (SP), side timber (ST), elements of plank fastening (clamps: orange; nails: green) and two boards.

elementi. Talni tramič je bil v prehodu skozi čolnico tudi zatesnjen z rastlinskim tesnilom (sl. 12: a).

### Bočna tramiča

Dokumentirana delno ohranjena bočna tramiča ST 1 in ST 2 sta nameščena ob ohranjenem boku (sl. 13). Prvi (ST 1) je debel približno  $8,5 \times 7$  cm, ohranjena višina je 31 cm, drugi (ST 2) je debel približno  $9 \times 7$  cm z ohranjeno dolžino do 45 cm. Oba tramiča sta v prehodu čolnice iz dna v bok polkrožno obtesana, da se prilegata krivulji prehoda (glej t. 4: 1, spodnji del preseka). Tramič ST 1 je na višini približno 11 cm z žebljem pritrjen na bočni del čolnice (sl. 13: desna puščica), tramič ST 2, ki ga žal ni bilo mogoče ohraniti *in situ*, pa ima na višini okoli 39 cm od dna v lesu ohranjen odlomljen žebelj (sl. 13: leva puščica; t. 4: 2), ki je najverjetneje spajal tramič z bočno platico (glej sl. 13: a; t. 4: a). Ta tramič je v spodnjem delu, kjer bi lahko, primerjalno z žebljem v bočnem tramiču ST 1, pričakovali žebelj za pritrjevanje na čolnico, na polovico odsekan v dolžini približno 26 cm.

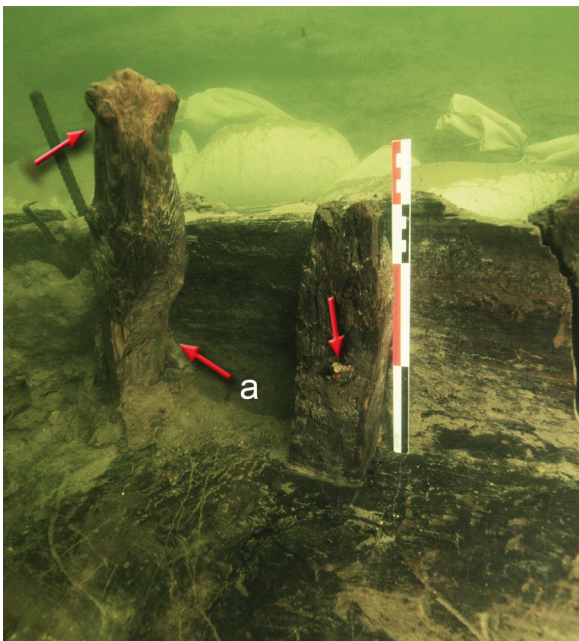

Sl. 13: Ladja iz Sinje Gorice. Bočna tramiča (ST 1 in ST 2) z dokumentiranimi žebljema ter domnevno zabitim žebljem (a), ki je spajal čolnico (CG 2) z bočnim tramičem (ST 2) (glej t. 4).

Fig. 13: Barge from Sinja Gorica. Side Timbers 1 and 2 with documented nails and a nail (a) presumably fastening China-girder 2 to Side Timber 2 (see Pl. 4).

(Foto / Photo: R. Kovačič)

### Tesnjenje in spajanje

Vsi stiki med platicami, čolnicama in talnima tramičema so zatesnjeni s pletenico iz vegetativnih delov (stebela in listi) trav<sup>43</sup> (*Poaceae*; sl. 8: vzorec 25; sl. 14: a,b) in tesnilom iz bukovega lesa (sl. 8: vzorec 21; sl. 14: c,d,e). Širina stikov med platicami je v povprečju 1,2 do 1,5 cm z najožjim delom 0,6 cm in najširšim 1,8 cm. Posebej izstopa stik med platico BP 1 in BP 2 (sl. 14: e; glej sl. 8), kjer je stik po vsej dolžini širok v povprečju 2,8 cm (od 2,5 do 3,2 cm).

Talne in bočne platice so bile spete z železnimi spojki. Narejene so bile iz železnega traku dolžin od 3,9 do 10,3 cm, širine od 1,2 do 2,3 cm in debeline 0,2 cm. Oba upognjena konca vsake spojke sta visoka od 0,8 do 2,8 cm (tab. 1).

Na raziskovanem delu ladje je bilo dokumentiranih 53 pritrjenih spojok (sl. 15; seznam 1), sledi na treh mestih pa kažejo na prisotnost spojok (sl. 15: g,h [št. 52–54]). V bližnji okolici ladje je bilo že leta 2008 delno pobranih 15 prostoležečih spojok v KV 36 in KV 37 (sl. 4; t. 1), ob raziskavi leta 2012 pa še 37 (sl. 16; t. 2; 3), skupaj torej 105 spojok.

Iz tako različnih mer je mogoče sklepati, da so tesarji pri gradnji ladje sproti izdelovali spojke. To je mogoče sklepati tudi iz dejstva, da upognjeni stranici spojke nista bili oblikovani v konico, temveč so ostale polkrožne ali pravokotne, kakor so bile odrezane oz. preščipnjene spojke (t. 2: 5,12,18).

Spojke sestavne dele ladje spajajo na približni razdalji 32 cm (od 17 do 47 cm), platice pa so spajane tako z notranje strani ladje kakor tudi z zunanje. O tem pričajo dokumentirane spojke (sl. 15: a,b [št. 41, 55, 56]). Kakor kaže, so bile razporejene na podobnih razdaljah kot tiste v notranjosti. To je mogoče sklepati iz razdalje med spojkami 55 in 56 (sl. 15). Pri večini zabitih spojok je bil opažen utor, ki je bil iztesan pred zabijanjem (sl. 18). Na podlagi teh utorov je bilo mogoče dokumentirati tudi manjkajoče spojke (sl. 15: g,h [št. 52–54]).

Pri dokumentiranju je bila opažena tudi zanimiva podrobnost, ki morda, skupaj s spojkami precej različnih velikosti, kaže na hitrost in morebitno površnost pri gradnji plovila. Spojka 25 je bila zabita samo v čolnico CG 1 (sl. 15: e), medtem ko se je spojka 51 med zabijanjem odlomila (sl. 15: c).

<sup>43</sup> Za sporočene podatke, podrobnejše analize vzorcev so sicer še v teku, se zahvaljujemo Tjaši Tolar z Inštituta za arheologijo ZRC SAZU in Jerneju Joganu s Katedro za botaniko in fiziologijo rastlin Oddelka za biologijo Biotehniške fakultete Univerze v Ljubljani.

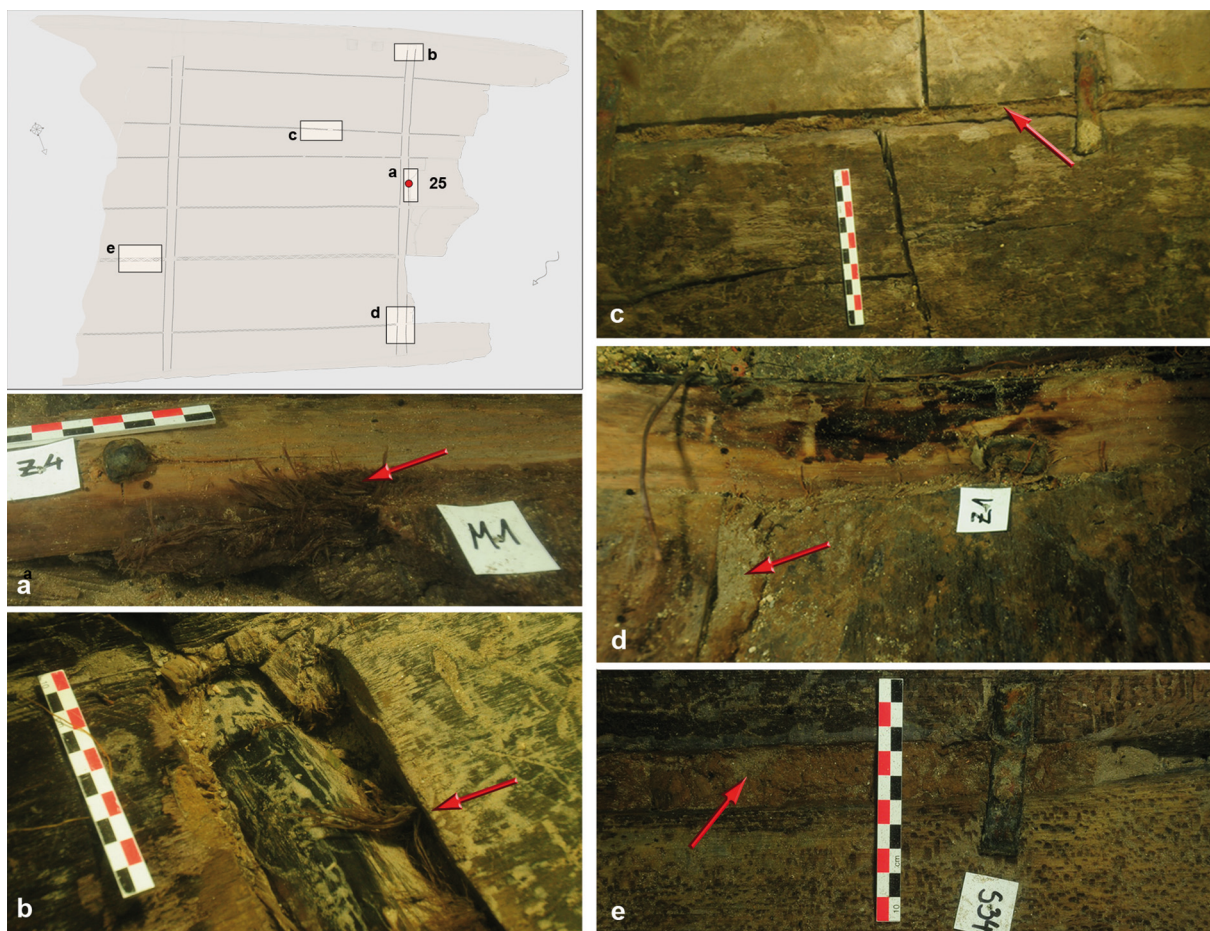

Sl. 14: Ladja iz Sinje Gorice. Dokumentirane sledi tesnil med platicami, čolnicami in talnimi tramiči. Mesto odvzema vzorca tesnila št. 25 (a). Nekaj značilnih pogledov (a–e) na tesnila.

Fig. 14: Barge from Sinja Gorica. Documented traces of caulking between planks, chine-girders and floor-timbers. Position of Sample 25 (a). Some typical views (a–e) of the caulking.

(Foto / Photo: R. Kovačič)

Tab. 1: Skupne mere spojk in žebeljev s povprečji (glej t. 1–4).

Tab. 1: Size of clamps and nails (see Pls. 1–4).

#### SPOJKE / CLAMPS

Skupno št. Total No.	Povprečje Average	Razpon vrednosti Range	Povprečje Average	Razpon vrednosti Range	Povprečje Average	Razpon vrednosti Range	Povprečje Average	Razpon vrednosti Range
	Dolž. L.	>= / <=	Šir. W.	>= / <=	Deb. Th.	>= / <=	Viš. H.	>= / <=
105	6,67	>3.9 / <10.3	1,59	>1.2 / <2.3	0,199	>0.15 / <0.2	1,94	>0.8 / <2.8

#### ŽEBELJI / NAILS

Skupno št. Total No.	Povprečje* Average*	Razpon vrednosti Range	Povprečje* Average*	Razpon vrednosti Range	Povprečje* Average*	Razpon vrednosti Range	* Povprečja na podlagi znanih mer / Based on known measurements
	Dolž. L.	>= / <=	Deb. Th.	>= / <=	Pr. glave Head diam.	>= / <=	
22	9,98	>8.1 / <12.5	0,62	>0.5 / <0.8	1,66	>1.5 / <1.9	

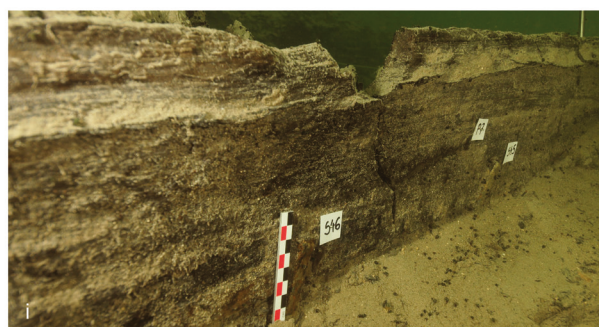
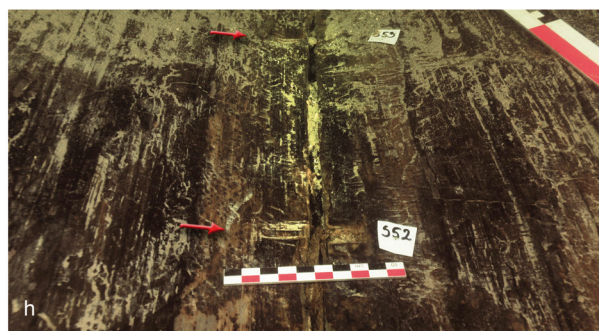
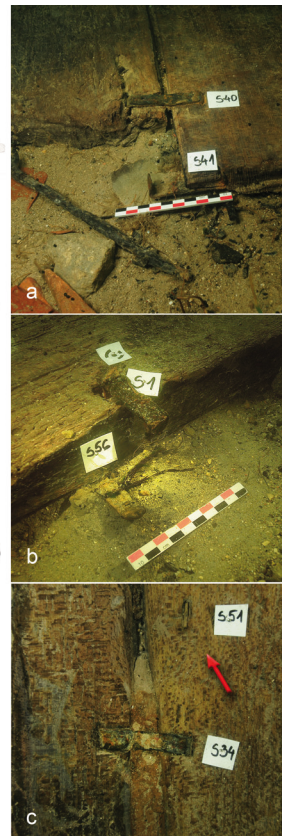
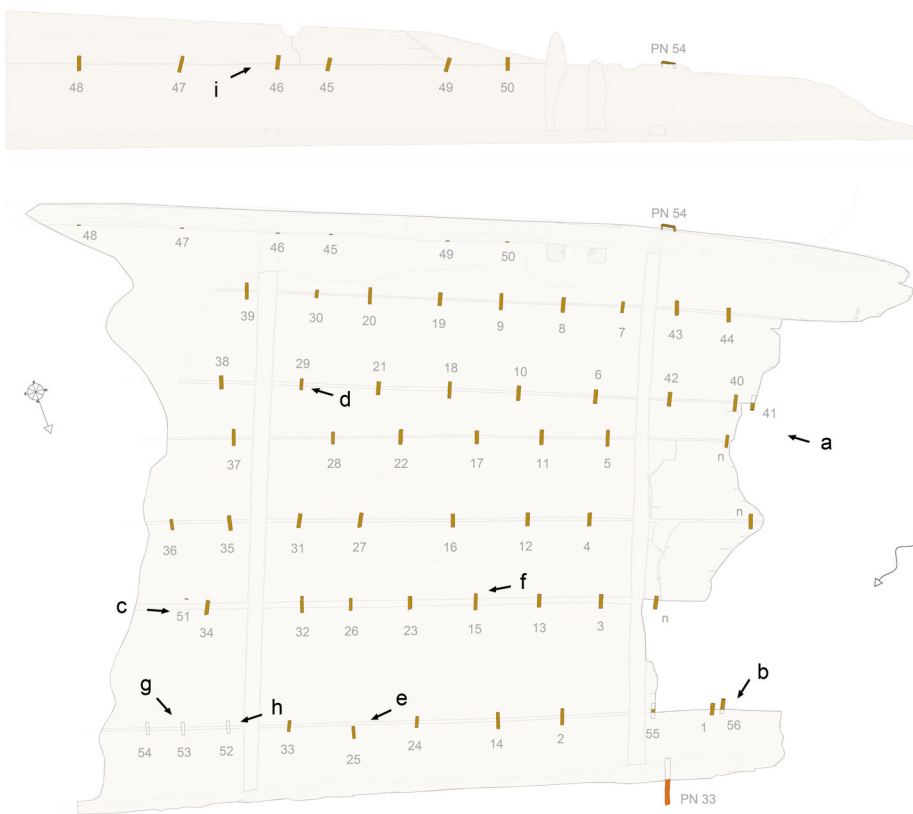

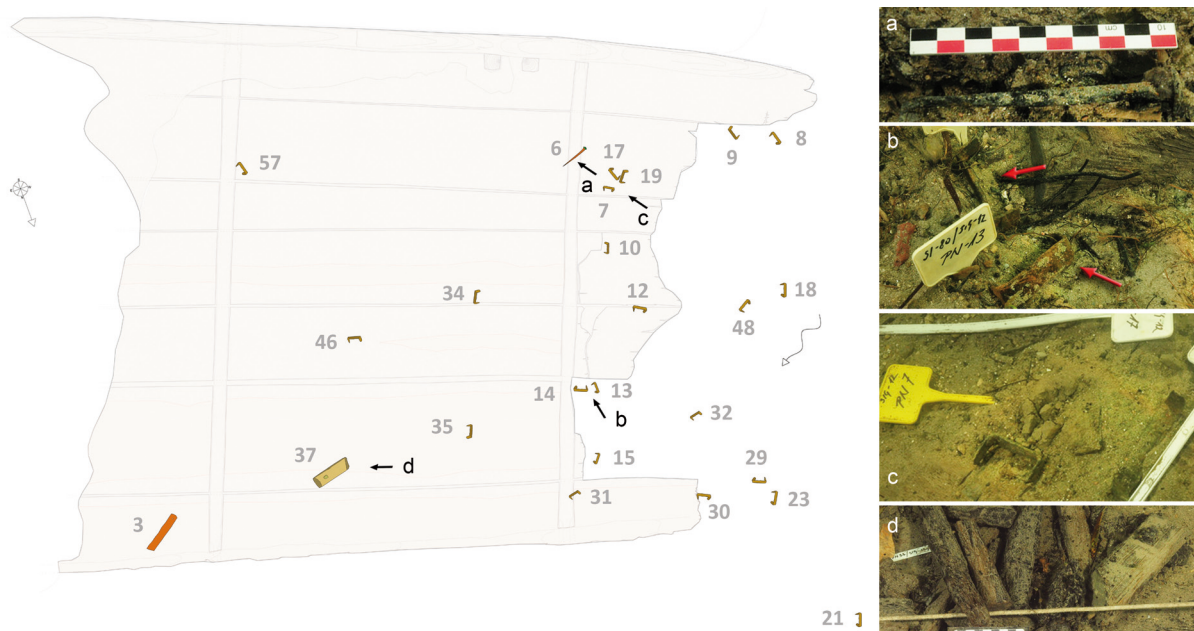

Sl. 16: Ladja iz Sinje Gorice. Tloris s prosto ležečimi spojkami (glej t. 2, 3).  
 Fig. 16: Barge from Sinja Gorica. Ground plan of the scattered clamps (see Pls. 2, 3).  
 (Foto / Photo: R. Kovačič)

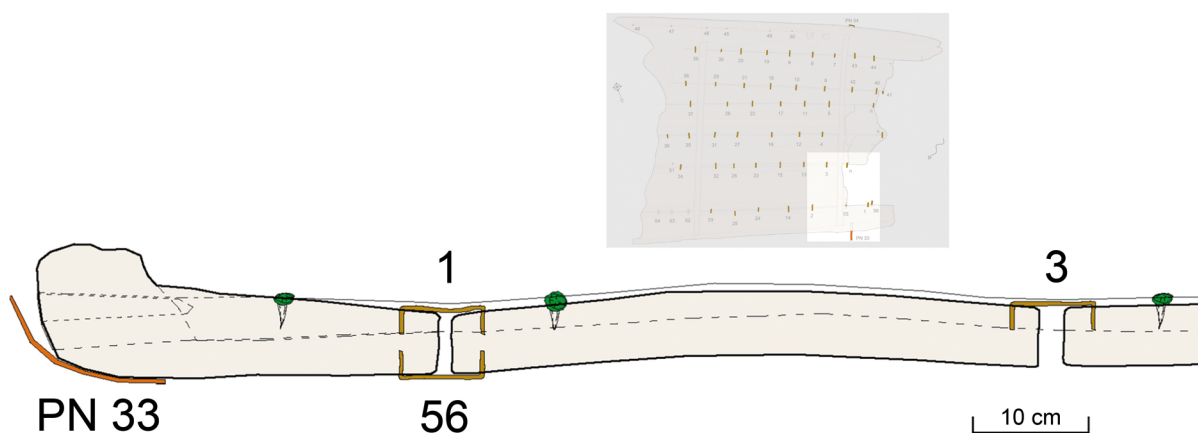

Sl. 17: Ladja iz Sinje Gorice. Poenostavljen presek čolnice (CG 1) in platice (BP 1) z lego spojko (glej sl. 15) in žabljev.  
 Fig. 17: Barge from Sinja Gorica. Simplified cross section of Chine-girder 1 and Bottom Plank BP 1 with marked positions of clamps (see Fig. 15) and nails.

←  
 Sl. 15: Ladja iz Sinje Gorice. Tloris z označenimi mesti posnetkov (a–h) in vzdolžni presek z notranje strani z zabiti spojkami (i).

Fig. 15: Barge from Sinja Gorica. Ground plan and longitudinal cross section from the interior with marked positions of the detailed photographs (a–h) and positions of the clamps in the wooden elements (i).  
 (Foto / Photo: R. Kovačič)

Za spajanje talnega tramiča na čolnici in talne platice so bili uporabljeni železni žablji (t. 3; seznam 1).

Med pregledi leta 2008 sta bila v KV 37 najdena dva žablja (t. 1: 16,17), oktobra 2012 pa še dva prostoležeča (sl. 19: a,b [PN 4, 6]; t. 3: 17,18). Dolžina prostoležečih žabljev je od 8,1 do 12,5 cm, z debelino trna od 0,5 do 0,8 cm ter premerom glave od 1,5 do 1,8 cm (tab. 1). Žablji so bili zabiti poševno pod



Sl. 18: Ladja iz Sinje Gorice. Poenostavljen presek utorov in nekaj izbranih spojk z utori.

Fig. 18: Barge from Sinja Gorica. Simplified cross section of a joint with a clamp in its groove and detailed photographs of several clamps.

(Foto / Photo: R. Kovačič)

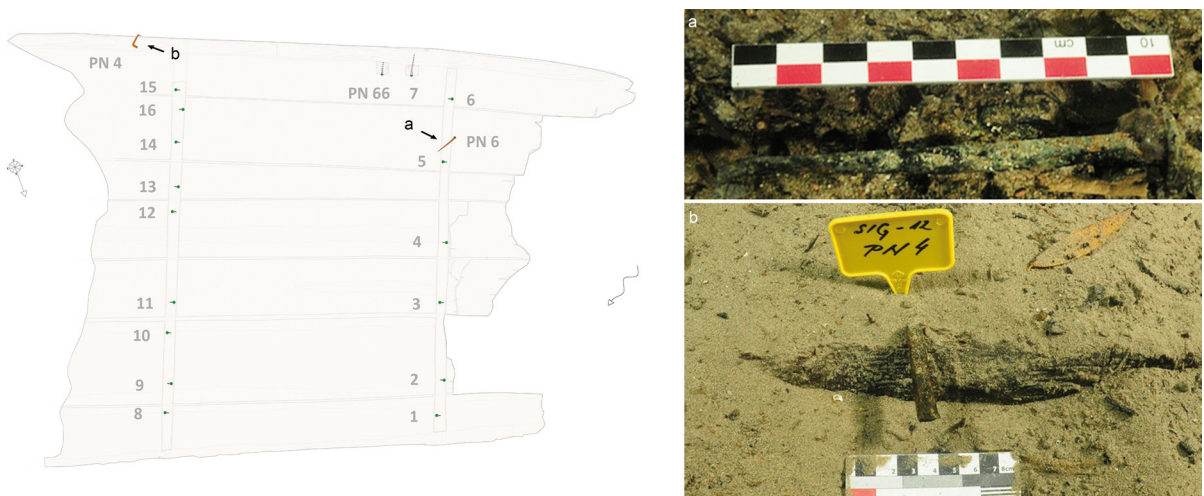

Sl. 19: Ladja iz Sinje Gorice. Železni žebelji (glej t. 3). a – Žebelj PN 6 je ležal v stiku z ladjo. b – Žebelj PN 4 je bil s konico zataknjen v bočno platico (SP 1), dokumentiran pa je bil ob začetku čiščenja ladje.

Fig. 19: Barge from Sinja Gorica. Iron nails (see Pl. 3). a – Nail PN 6 lying in contact with the barge. b – Tip of Nail PN 4 inserted into Side Plank 1, documented at the beginning of the clean-up of the barge.

(Foto / Photo: R. Kovačič)

kotom približno 60°, vsak naslednji z druge strani, skozi talni tramič v talno platico (sl. 20). V talni tramič FT 1 je bilo zabitih 6 žebeljev, v talni tramič FT 2 pa 9 žebeljev (glej sl. 19). Z žebli sta bila na oplato pritrjena tudi bočna tramiča ST 1 in ST 2. Ob dokumentiranju je bil bočni tramič ST 1 še vedno čvrsto pritrjen na čolnico CG 2 (sl. 19: žebelj 7), medtem ko je bočni tramič ST 2 ob bok pritiskal zgolj sediment v okolici. Razlog za to je mogoče iskati v

namenski poškodbi bočnega tramiča ST 2, ki je bil odsekan v spodnji polovici, pritrjeni ob čolnico v prehodu od dna v bok v dolžini približno 26 cm. V zgornjem delu tramiča je v lesu še vedno odlomljen žebelj (sl. 19: PN 66; t. 4: 2). Kot je mogoče sklepati po obliki obsekanine, je to bilo narejeno zato, da se tramič loči od boka. Oba tramiča sta bila v delu, ki se prilega v koleno prehoda iz dna v bok, obtesana tako, da sta se lepo ulegla v krivino.

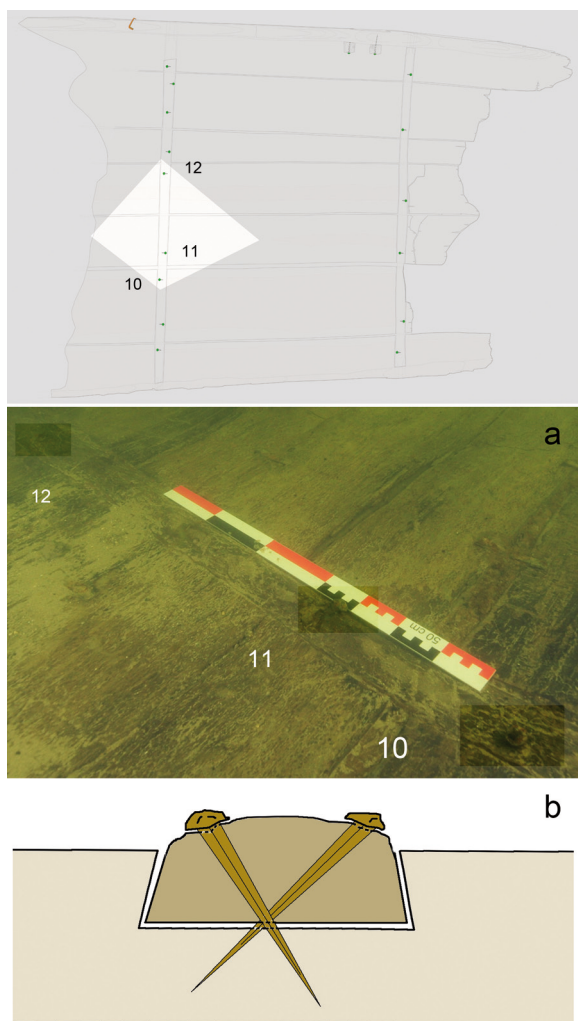

Sl. 20: Ladja iz Sinje Gorice. Lega železnih žabljev PN 10, 11, 12 (glej sl. 19; seznam 1) na talnem tramiču FT 2. **a** – Žablja PN 10 in 12 sta zabita z leve v smeri pogleda, 11 pa z desne. **b** – Shematičen prikaz načina zabijanja žabljev pod kotom.

Fig. 20: Barge from Sinja Gorica. Position of iron Nails PN 10, 11, 12 (see Fig. 19; List 1) in Floor-timber 2.

**a** – Nails PN 10 and 12 were driven in from the left and Nail 11 from the right. **b** – A schematic view of nails driven under an angle.

(Foto / Photo: R. Kovačič)

## Obdelave, sledi uporabe in drugo

Med dokumentiranjem je bilo opaženih nekaj sledi obdelave, ki najverjetneje niso nastale ob gradnji ladje, temveč kasneje, med njeno rabo. Najizrazitejši obdelavi sta prevrtani izdolbini na bočni platici SP 1 in čolnici CG 2. Prva obdelava, prevrtana bočna platica SP 1, ki ima premer 10 cm (sl. 21: b), je skoraj v osi talnega tramiča FT 2.

Zaradi pomanjkanja drugih podatkov ali dokazov ni mogoče z gotovostjo ugotoviti njene namembnosti. Zaradi lege ladje v sedimentih in izpostavljenosti delovanju vodnega toka so v tisočletjih nastale močne abrazivne poškodbe na delno ohranjeni zahodni bočni platici. Zato je mogoče sklepati, da je bila v času uporabe bočna platica prevrtna (sl. 22: b), luknja pa je bila morda namenjena nameščanju lesenega droga, ki bi lahko povezoval oba boka (glej sl. 26). Podobna se zdi izvrtina, ki je bila dokumentirana na čolnici CG 2 tik nad talnim tramičem FT 1 in ob bočnem tramiču ST 1. Premer te obdelave je okoli 13 cm, služila pa bi lahko podobnemu namenu (sl. 21: c; 22: c).

Iztesani utor v talnih platicah BP 3, 4 in 5 (sl. 21: e) poteka pravokotno čez ladjo v isti osi kot izdolbina na bočni platici (sl. 21: a). Slutiti ga je mogoče tudi na platicah BP 1 in 2, vendar ni povsem zanesljivo. Pomisliti gre, da je bil utor narejen za čvrsto nameščanje prekata. Sicer neugotovljene namembnosti je usekana polkrožna vdolbina na talnem tramiču FT 2 (sl. 21: d), je pa mogoče sklepati, da je bila narejena kot ležišče za okrogel predmet, ki naj se ne bi premikal.

Les večine elementov na ladji, še zlasti bočne in talnih platic, je zelo degradiran (glej sl. 9: a,b), kar je mogoče opazovati tudi skozi množico razpokanin in poškodb zaradi popuščanja celične strukture in s tem "uleganja" in prilagajanja lesa na sedimente (sl. 21: f; 10: D,E). Zaznan je še rob na bočni platici SP 1 (sl. 21: g). Ali gre dejansko za namensko obdelavo ali s sedimenti abraziran rob, ta hip še ni jasno, v primeru pa, da je rob iztesan, bi ga bilo mogoče razumeti kot oporo za nameščanje dodatnih lesenih elementov med obema bokoma.

Na ladji sta v stiku z lesom med čolnico CG 2 in talno platico BP 5 ležali dve leseni deščici, katerih uporabe ni bilo mogoče ugotoviti (sl. 10; 23). Prav tako ni mogoče z gotovostjo trditi, ali sta sploh povezani z uporabo ladje.

Erič

## 6. ZAPOREDJE GRADNJE IN OBLIKA

### Zaporedje

O zaporedju gradnje je mogoče na podlagi dokumentiranih ostankov sklepati naslednje:

1. Zunanji obris ladje sta določali simetrično oblikovani čolnici (CG 1 in CG 2) z indeksom širjenja 1,19 oziroma 1,18 proti sredini ladje. Fak-

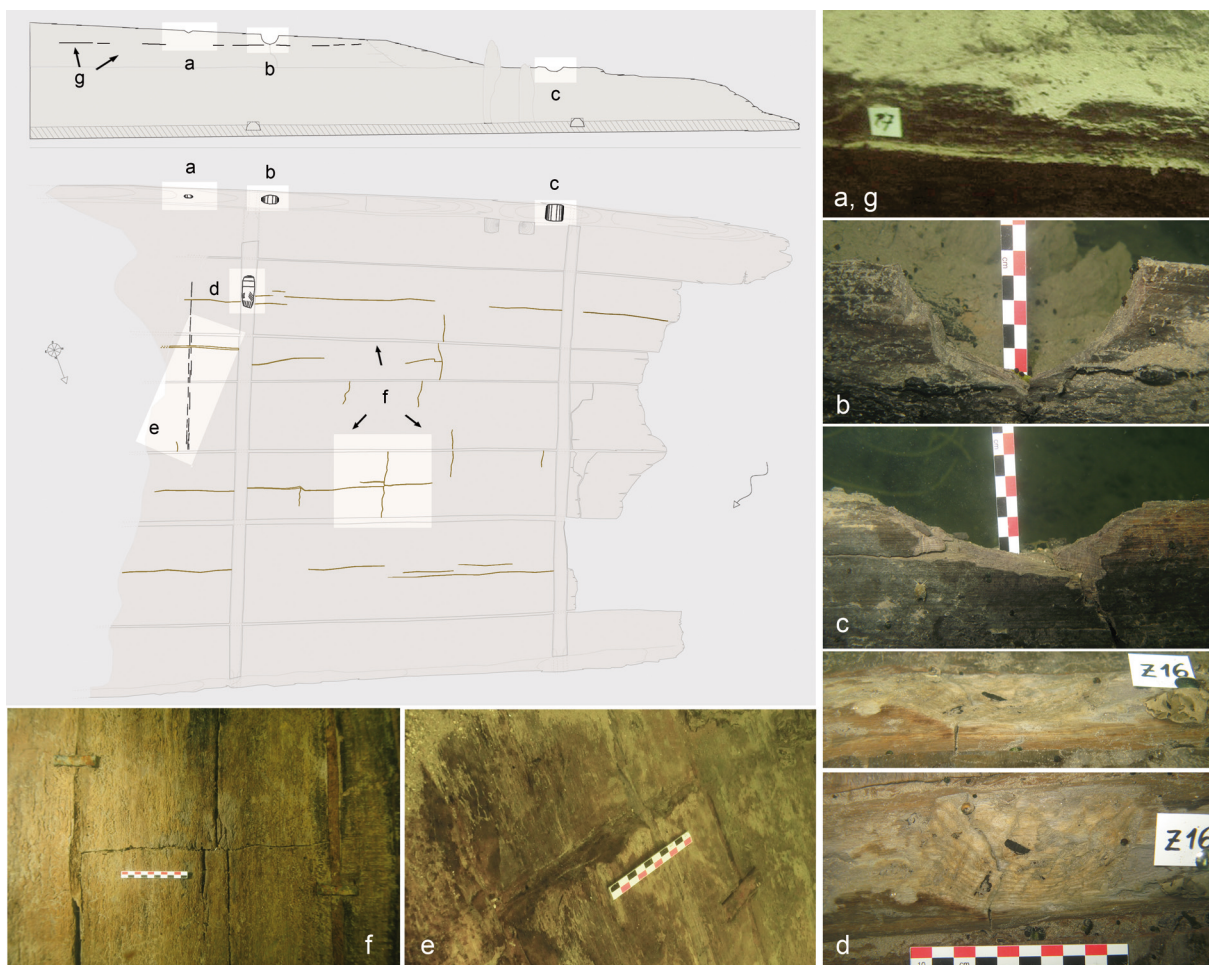

Sl. 21: Ladja iz Sinje Gorice. Podrobnosti na konstrukciji. **a** – Izdolbina v bočni platici (SP 1); **b** – skozi bočno platico (SP 1) prevrtana luknja tik nad talnim tramičem (FT 2); **c** – skozi bočno platico (SP 1) prevrtana luknja tik nad talnim tramičem (FT 1); **d** – polkrožno obtesani talni tramič (FT 2) nad talno platico (BP 5); **e** – utor v talnih platicah (BP 3, 4, 5) poteka prečno čez ladjo v isti osi kot izdolbina **a**; **f** – skupina poškodb in razpok, ki niso posledica obdelave temveč postopnega propadanja lesa; **g** – rob na bočni platici (SP 1), ki je morda namensko narejen.

Fig. 21: Barge from Sinja Gorica. Construction details. **a** – Hole in a side plank (SP 1); **b** – hole in a side plank (SP 1) above the floor-timber (FT 2); **c** – hole in a side plank (SP 1) above the floor-timber (FT 1); **d** – hemispherical indentation in the floor-timber (FT 2) above a bottom plank (BP 5); **e** – groove across the bottom planks (BP 3, 4, 5) running in the same axis as the hole on **a**; **f** – cracks and other damage not made during construction, but a result of progressive wood degradation; **g** – possibly intentionally made groove in a side plank (SP 1).

(Foto / Photo: R. Kovačič)

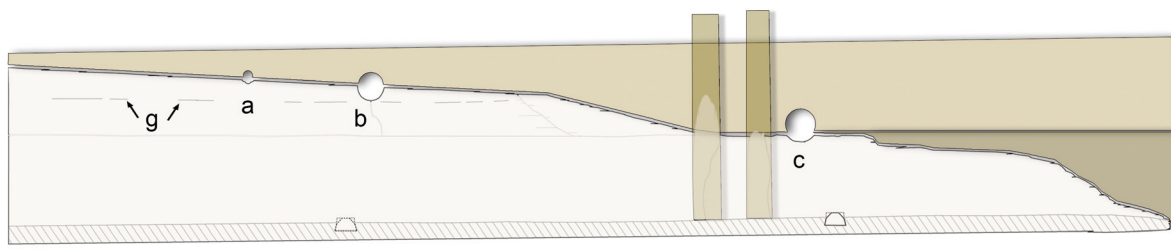

Sl. 22: Ladja iz Sinje Gorice. Poskus rekonstrukcije ohranjenega boka (glej sl. 21).

Fig. 22: Barge from Sinja Gorica. Attempt at a reconstruction of the surviving side (see Fig. 21).



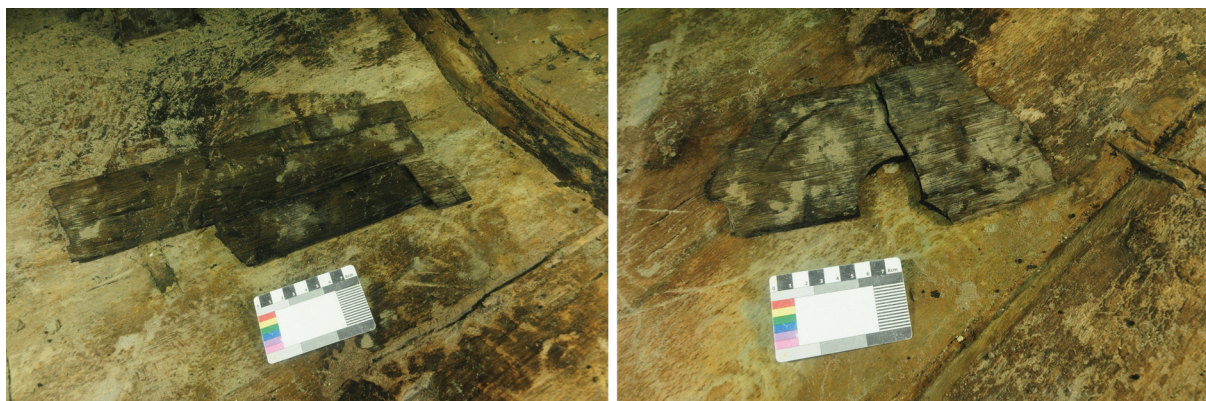

Sl. 23: Ladja iz Sinje Gorice. Lega lesenih deščic na ladji (glej sl. 10).

Fig. 23: Barge from Sinja Gorica. Position of the wooden boards on the barge (see Fig. 10).

(Foto / Photo: R. Kovačič)

tor širjenja platic (BP 1–BP 5) v petih vzporednih nizih je manjši in obsega okoli 1,06, razen pri BP 4, ki se s faktorjem 1,56 opazneje oži proti koncu plovila. Stik med platicama BP 2 in BP 3 poteka po sredinski osi plovila, pri čemer eno polovico talnega dela oplate oz. školjke sestavljata dve platici (BP 1 in BP 2), drugo pa tri platice (BP 3 do BP 5). Povedano nakazuje, da je bila oblika vseh opazovanih delov načrtovana in prefabricirana (glej sl. 10).

2. Pred fiksiranjem čolnic in talnih platic so mednje vstavili tesnilo iz bukovega drobirja in pletene vrvi iz rastlinskih vlaken in ga morda že v tej fazi učvrstili z zabijanjem spojk čez stike platic in čolnic na notranji strani ali pa so talno oplato in čolnice med gradnjo držale skupaj zagozde, zataknjene v stojala ob zunanjih robovih dna.

3. Sledili sta izdelava utorov za spojke na notranji površini talnih platic ob stikih in utorov za tramiče v talne platice in čolnice, nato pa namestitev tramičev, ki so jo verjetno izvedli s postopnim vrinjanjem skozi eno od odprtih v čolnicah; z notranje strani so talne tramiče na platice pritrčili s poševno zabitimi železnimi žebli, medprostor v utorih med čolnico in tramiči pa so na zunanji strani (verjetno) zatesnili s sno-piči rastlinskih vlaken, učvrščenimi z majhnimi lesenimi zagozdami.

4. Verjetno so v naslednji fazi tako pripravljeno dno s čolnicama prekopicnili in zabili spojke čez stike platic na zunanji strani.

5. V naslednji fazi so namestili bočne tramiče, na drugih delih plovila pa je sočasno verjetno potekala vgradnja ogrodja; sledilo je nameščanje

zgornjih nizov bočnih platic in njihova dodelava (odprtine za prečne drogove).

6. Na koncu, če tega niso storili že prej, so zabili še spojke čez stike na notranji strani školjke in na zunanji strani bokov.

### Oblika

Opravljen je bil preizkus ujemanja oblike ladje iz Sinje Gorice z nekaterimi rimskimi ladjami z ravnim dnom iz severnosredozemskega zaledja ter tistimi iz severozahodne Evrope.<sup>44</sup> Izkazalo se je, da se krivina bokov ladje dobro prilega krivinam bokov ladij iz Lip<sup>45</sup> in Bevaixa ter ladjama Yverdonles-Bains 1<sup>46</sup> in Arles-Rhône 3<sup>47</sup> na približno prvi tretjini plovila, krivina bokov ladje iz Sinje Gorice pa sploh ni primerljiva z boki ladij poreske skupine, saj so te ladje v prvi in zadnji petini precej ostro zakrivljene ali zalomljene v premec in krmo, v kar treh petinah ladje pa sta boka vzporedna (sl. 24).

Opozoriti je treba še na primerjalni test krivin bokov med izbranimi ladjami severnosredozemskega zaledja s krivino boka ladje iz Sinje Gorice (sl. 25: a). Ta je namreč pokazal zanimivo podrobnost, da imajo izbrane ladje pri isti širini skoraj povsem

<sup>44</sup> Tlorisi izbranih ladij so povzeti po gradivu s spletne strani NAVIS I. (<http://www2.rgzm.de/Na-vis/home/frames.htm>), razen ladje Arles-Rhône 3 (<http://www.daily-motion.com/video/xl3bti-arles-rhone-3-de-la-fouille-a-la-restitution-du-chaland-gallo-romain-creation.UVMTWULfATM>) in ladje iz Lip (Gaspari 1998a).

<sup>45</sup> Gaspari 1998a.

<sup>46</sup> Arnold 1992.

<sup>47</sup> Djaoui, Greck, Marlier 2012.

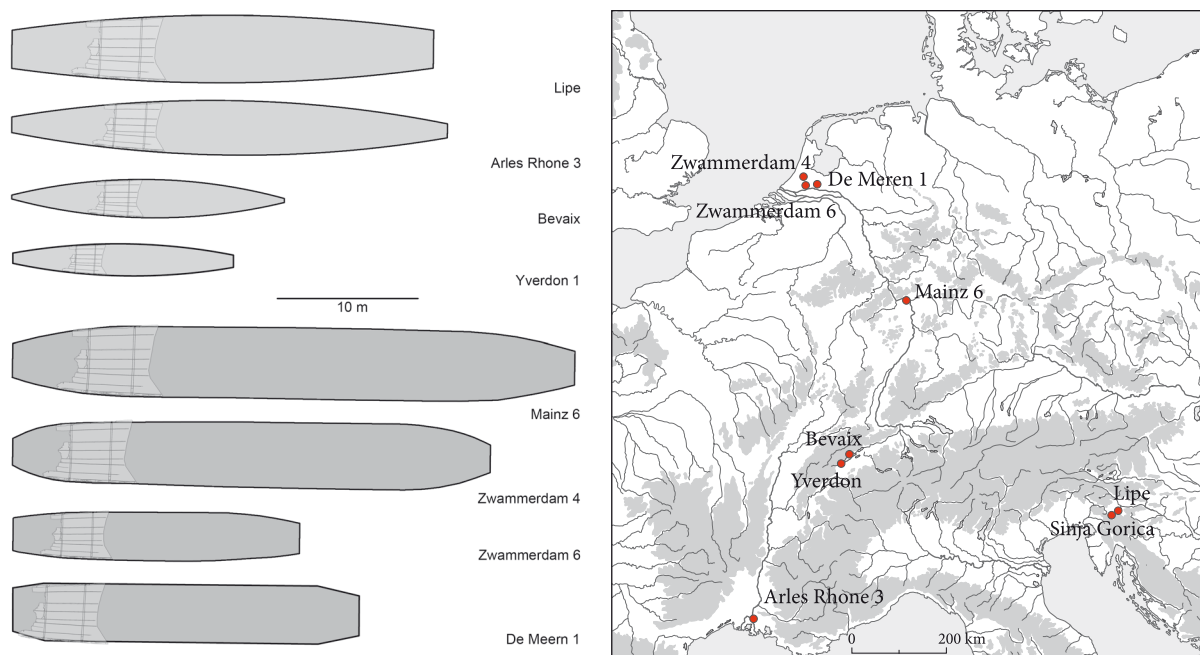

Sl. 24: Primerjava štirih izbranih ladij severnosredozemskega zaledja (Lipe, Arles-Rhône 3, Bevaix, Yverdon-les-Bains 1) in štirih izbranih ladiji porenske skupine (Mainz 6, Zwammerdam 4 in 6, De Meern 1) s severa Evrope. Raziskani del tlorisa ladje iz Sinje Gorice je prirejen vsaki ladji posebej.

Fig. 24: Comparison of four selected ships from the northern Mediterranean hinterland (Lipe, Arles-Rhône 3, Bevaix, Yverdon-les-Bains 1) and four of the Rhineland group (Mainz 6, Zwammerdam 4 in 6, De Meern 1) from the north of Europe. For comparative purposes, the documented part of the barge from Sinja Gorica is inserted in each of the ships' ground plans.

Sinja Gorica  $r = 37$  m\*; Lipe  $r = 68$  m; Arles Rhone 3  $r = 61$  m; Bevaix  $r = 40$  m; Yverdon 1  $r = 52$  m

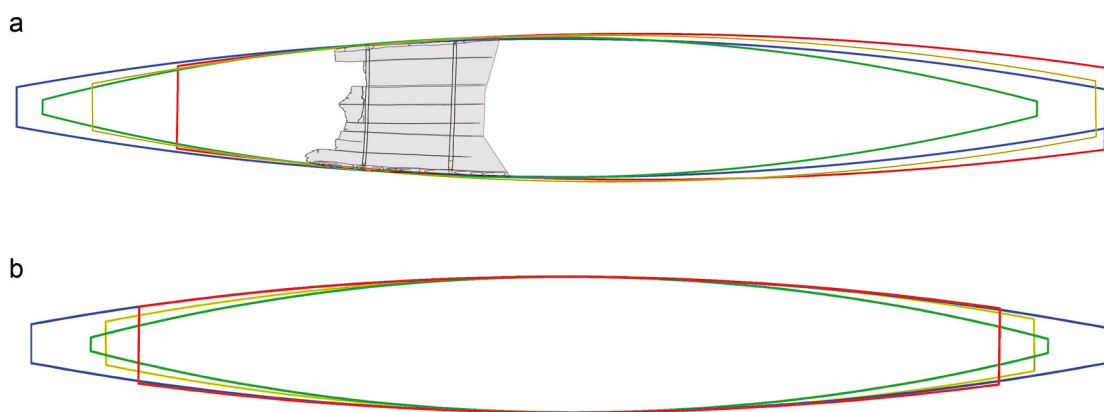

enotna širina za vse ladje / common width for all ships = 2,8 m

Sl. 25: Primerjava štirih izbranih ladij severnosredozemskega zaledja. **a** – Obliki ladje iz SG so bile ostale ladje za analizo povečane/pomanjšane na ustrežno velikost, pri kateri so se krivine bokov prekrivale. **b** – Vse ladje iz primerjave so bile povečane/pomanjšane na isto širino. Premer krivine boka (\*) ladje iz Sinje Gorice, zaradi kratkega odkritega dela boka in odsotnosti premca in/ali krme, za zdaj še ni najbolj zanesljiv.

Fig. 25: Comparison of four selected ships from the northern Mediterranean hinterland. **a** – Ship size adjusted (reduced/enlarged) so as to get the best possible match with the curvature of the barge from Sinja Gorica. **b** – Ship size adjusted to the same width. The documented section of the barge from Sinja Gorica is short and missing the bow, hence the diameter of its side curvature (\*) is only an estimate.

enak premer krivine boka (*sl.* 25: b). Odstopa le ladja iz Bevaixa. Širina zrcal premca in krme pa je v soodvisnosti od dolžine ladje. Ali gre pri štirih ladjah (do petih, vključno z ladjo iz Sinje Gorice) za pravilo ali morda za naključje, bo treba počakati še na kakšno novo najdbo in opraviti podrobnejše primerjave med izbranimi plovili.

*Erič*

## 7. PRIMERJALNA ANALIZA KONSTRUKCIJSKIH IN TEHNOLOŠKIH ZNAČILNOSTI LADJE IN NJENO MESTO V REGIONALNIH LADJEDELNIŠKIH PRAKSAH

Nadaljevanje terenskih raziskav plovila v letu 2012 in izvedene naravoslovne preiskave so prispevali deloma presenetljive podatke, ki v marsičem precej spreminjajo predhodne ugotovitve.<sup>48</sup> Tudi tokratna analiza je zaradi omejene raziskanosti ostankov lahko le delna in začasna.

Odrpta oblika s skoraj navpičnimi stranicami, razporeditev platic talne in bočne oplata, način zagotovitve vodotesnosti in druge konstrukcijske značilnosti ne dopuščajo dvomov, da gre za plovni objekt, katerega znane dimenzije ustrezajo tistim pri okvirno sočasnih tovornih ladjah.

Oblika in konstrukcija ladje odsevata koncept vzdolžno potekajoče školjke, na katerem je temeljila sredozemska ladjedelniška praksa vse do konca antike. V tej tradiciji je bila najprej samostojno sestavljena školjka, ogrodje pa vstavljeno pozneje. Ladja iz Sinje Gorice sodi v okviru te tradicije v skupino plovil z ravnim dnom, katerih oblika je bila zasnovana iz dna in v bočnih delih zgrajena s pomočjo začasnega notranjega ali zunanjega ogrodja (*fr. construction sur sole*).

Analiza tlorisnega obrisa raziskanega dela dna in bokov je razkrila, da gre verjetno za segment plovila približno na tretjini celotne dolžine ladje glede na premec ali krmo. Odsotnost sledov trdnejšega in gostejše razmeščenega talnega ogrodja (kot so izmenično nameščeni masivni tramiči in rebra ali pari masivnih tramičev s kolenastimi bočnimi deli s sorodnih tovornih ladij) ter prečni utor ob tramiču FT 2 (glej *sl.* 21: e), ki bi lahko kazal na premično prekatno steno, sta morda povezana z lažjim nalaganjem in skladiščenjem tovora, pri čemer so odpornost tega dela plovila proti bočnemu pritisku po nalaganju verjetno zagotovili z

namestitvijo prečnih drogov (glej *sl.* 21: b,c; 26), če je taka interpretacija lukenj v bokih pravilna, ali z drugačnim začasnim ogrodjem. Možnost, da bi bila na ta način narejena celotna ladja, je zelo majhna, če ne nemogoča, saj boki plovila pod določenim ugrezom ne bi zdržali pritiska vode, vprašljiva pa je tudi odpornost talne oplata, povezane le s široko razmaknjenimi tramiči in spojki. Na raziskanem delu ladje namreč ni bil dokumentiran noben drug način spajanja oplata, npr. z lesenimi mozniki ali v tehniki na pero in utor, tj. deščicami, vstavljenimi v utore, izdolbene v bočne robove platic. Verjetnost obstoja masivnejšega ogrodja podpirajo najdbe železnih žebeljev zunaj prvotne lege, med katerimi je tudi primerek z dvakrat zakrivljeno konico (glej *sl.* 19: b [PN 4]; t. 3: 17).

Novoodkrita ladja pomembno dopolnjuje spoznanja o pomenu regionalnih ladjedelniških praks vzhodne in severne obale Jadranskega morja pri konstruiranju rimskih tovornih ladij celinskega tipa, saj skupaj z okvirno sočasno, okoli 30 metrov dolgo in do 4,8 m široko ladjo z 0,60 m visoko ohranjenimi boki iz Lip<sup>49</sup> sodi med najzgodnejše znane primere teh enkratnih dokazov obsega in zmogljivosti rečnega transporta v rimskem obdobju.<sup>50</sup>

Ladja iz Lip, pri kateri je uporaba že rabljenega lesa povzročila kar nekaj nejasnosti pri določitvi starosti z radiokarbonsko metodo, je bila glede na najmlajša od petih analiziranih vzorcev zgrajena v drugi polovici 1. st. pr. n. št. ali prvih desetletjih 1. st. n. št.<sup>51</sup> V študijah o antičnem ladjedelništvu se obravnava kot prototip t. i. rimsko-keltskih tovornih ladij, med 18 in 40 m dolgih in do 5 m širokih plovil z ravnim dnom, strmimi boki z višino med 0,5 in 1,2 m ter poševnima premcem in krmo, ki so izdelana skoraj izključno iz hrastovine. Okoli 30 znanih plovil tega tipa z ozemlja med južno Francijo, spodnjim Porenjem in spodnjim Podonavjem sodi v čas med avgustejskim obdobjem in 3. stoletjem ter po dosedanjih spoznanjih pripada vsaj štirim regionalnim praksam.<sup>52</sup> Uporabljene tehnologije kažejo večinoma na sredozemski izvor, določenim konstrukcijskim rešitvam, npr. tesnjenju z mahom in uporabi železnih žebeljev,

<sup>49</sup> Gaspari 1998a; 1998b; 2009a; Bockius 2000, 465–468.

<sup>50</sup> Najstarejši znani ostanki rimske rečne ladje z ravnim dnom pripadajo leta 2008 odkritemu plovilu šivanega tipa iz 2. st. pr. n. št. z lokacije Motta di Cavanella d'Adige v Benečiji, ki ga izkopavalec pripisuje rimsko-padski tradiciji (Tiboni 2009).

<sup>51</sup> Gaspari, Erič 2012, 295, t. 1.

<sup>52</sup> Glej Bockius 2000; Guyon, Rieth 2011; Holk 2011.

<sup>48</sup> Gaspari, Erič 2012.

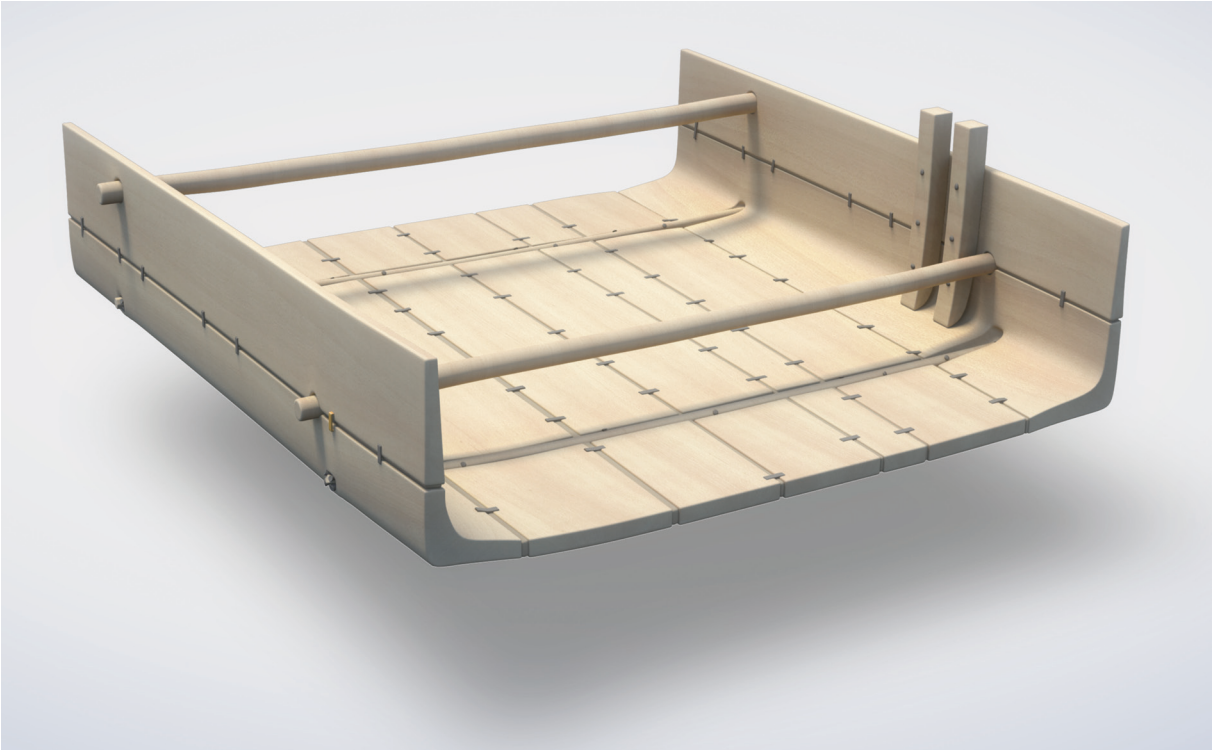

Sl. 26: Ladja iz Sinje Gorice. Rekonstrukcija odkritega dela in začasna interpretacija morebitne namembnosti lukenj v ladijskih bokih.

Fig. 26: Barge from Sinja Gorica. Reconstruction of the uncovered part and possible function of the holes in the barge sides. (Rekonstrukcija / Reconstruction: P. Petrović, L. Ritonja, ©ArtRebel9)

pa sledimo v prazgodovino celinske in atlantske Evrope. Keltskodobni prototipi plovil s sestavljeno oplato niso znani, zato prevladuje mnenje, da so t. i. rimsko-keltske tovrne ladje rimski odziv na specifične razmere celinske plovbe in povečane zahteve glede zmogljivosti.

V okviru tovornih ladij z ravnim dnom porenske skupine oz. tradicije se pojavljajo zlasti plovila osemkotnega obrisa z dolgim osrednjim delom z vzporednima stranicama, navpičnimi boki ter poševno nagnjenima koncema, ki sta omogočala lažje nalaganje in pristajanje. Hidrodinamično učinkovitejša elipsoidna oblika s prisekanima koncema je značilna za ladje skupine Rhône-Saône in nekatere ladje alpske skupine, ki so ji pripisana plovila iz zahodnošvicarskih jezer. Dokumentirana razmerja med širino in dolžino, ki se večinoma gibljejo med 1: 5,7 in 1: 7,1, nakazujejo določeno normiranje proporcev. Metrološko načrtovanje je izkazano tudi v razporeditvi elementov ogrodja določenega dela tovrstnih plovil v ponavljajočih razmikih 59 do 60 cm, kar ustreza dolžini dveh rimskih čevljev (1 *pes monetalis* = 29,6 cm).

Poenostavljeno se je gradnja rimsko-keltskih tovornih ladij začela z določitvijo obrisa in dimenzij dna in zlaganjem talnih platic v vzdolžne nize ali razpoložljivemu materialu prilagojen nepravilen mozaik. Prehod dna v večinoma navpične boke so izvedli s čolnicami, ki so bile zvišane z eno ali dvema dodatnima bočnima platicama. Te so bile zložene ali rob na rob v obliki tekoče oplate ali pa v tehniki klinker, pri kateri se robovi platic delno prekrivajo. Že pred namestitvijo bočnih platic so na dno položili pare prečno potekajočih tramov, ki so vsak na enem koncu kolenasto prehajali v rebra, segajoča do vrha bokov. Druga izvedba ogrodja je predvidevala vgradnjo izmenjujočih se prečnih tramičev in reber. Ogrodje je bilo na talne platice praviloma pritrjeno z železnimi žebli, mestoma tudi z lesenimi mozniki. Bočne platice so bile s pomočjo pomožnega ogrodja nameščene pred vgradnjo reber ali pa po njej, pri čemer so, obratno kot pri prvi možnosti, pritrdili platice na rebra. Pri spajanju oplate so pri nekaterih plovilih uporabili kombinacijo klasične tehnike na pero in utor (ang. *mortice and tenon*) in posamičnih

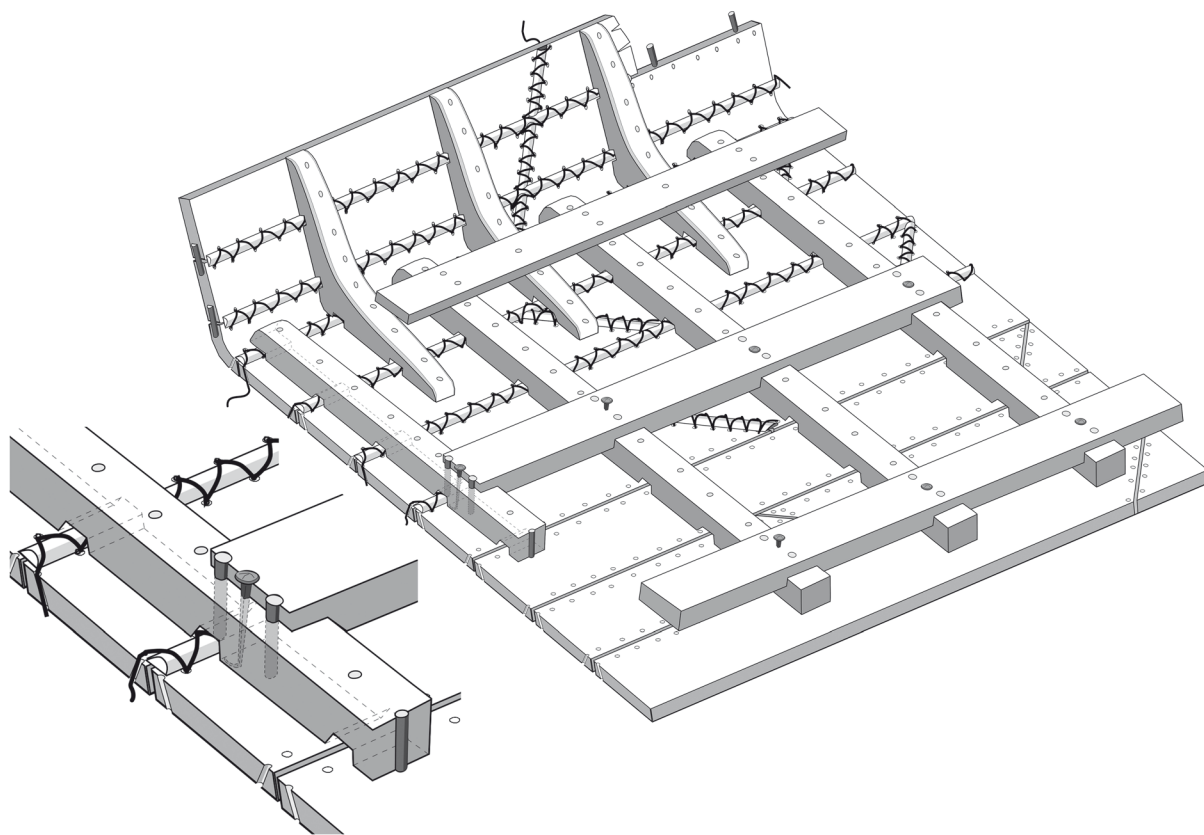

Sl. 27: Zgodnjerimska tovorna ladja iz Lip. Konstrukcijske značilnosti.

Fig. 27: Early Roman barge from Lipe. Construction features.

(Po / After Salemke 1973; Gaspari 1998b)

poševno zabutih žebeljev. Tesnilo iz mahu, rastlinskih vlaken ali tekstila, namočenega v smolo, je bilo nameščeno med platice bodisi pred njihovim zlaganjem oz. nameščanjem ali nabitno v vnaprej pripravljene špranje na notranjih stikih platic. Tesnilo so v nekaterih primerih učvrstili z gosto nabitimi železnimi žeblički ali s trakovi tekstila, posamično so najdene tudi železne spojke.

Ključna tehnološka razlika, ki ladjo iz Lip loči od ostalih rimskodobnih rečnih in jezerskih ladij iz evropske celine onkraj alpskega loka, je tehnika šivanja, s katero so speli posamezne elemente oplata, potem ko so v zgornjo polovico stikov med platicami namestili tesnilo iz snopov lipovega ličja (sl. 27). Cilindričen utor, izvrtan v stranski rob ene od platic, dokazuje dodatno spajanje oplata z lesenimi mozniki,<sup>53</sup> ki so v procesu gradnje olajševali šivanje in sočasno preprečevali vzdolžne premike med platicami. Uporaba valjastih (ang. *dowels*) ali pravokotnih (ang. *coaks*) moznikov, ki se približuje domnevno feničanski tehnologiji spajanja oplata v

tehniki na pero in utor (*coagmenta puniciana*), je pri morskih plovilih iz grškega kulturnega konteksta [npr. ladjah Marseille Jules-Verne 9 (585–550 pr. n. št.; sl. 28), Bon-Porté pri Saint-Tropezu (530–525 pr. n. št.), Cala Sant Vicenç na severovzhodni obali Mallorce (530–500 pr. n. št.) in Pabuç Burnu na jugozahodni obali Turčije pri Bodrumu (570–560 pr. n. št.)]<sup>54</sup> pomenila bistven del spajanja oplata, v okviru katerega je šivanje nadomeščalo zatiče peres pri omenjenih spojih Feničanom pripisane prakse in preprečevalo razmikanje spojev ter utrdilo tesnilo. Leseni mozniki so bili v mlajših obdobjih uporabe tehnike šivanja večinoma opuščeni oziroma, kot morda v primeru ladje iz Lip, uporabljeni samo za nekatere dele oplata, najverjetneje zaradi gosteje razmeščenih elementov ogrodja, ki je zagotavljalo zadostno trdnost školjke in celega plovila v vzdolžni in prečni smeri.<sup>55</sup>

Šivanje kontinuiranega tipa, ki je v Sredozemlju arheološko morda prvič dokazano pri leta 2008

<sup>53</sup> Gaspari 1998b, 534, 541.

<sup>54</sup> Polzer 2009.

<sup>55</sup> Beltrame 2000, 93; Beltrame, Gaddi 2013, 299.

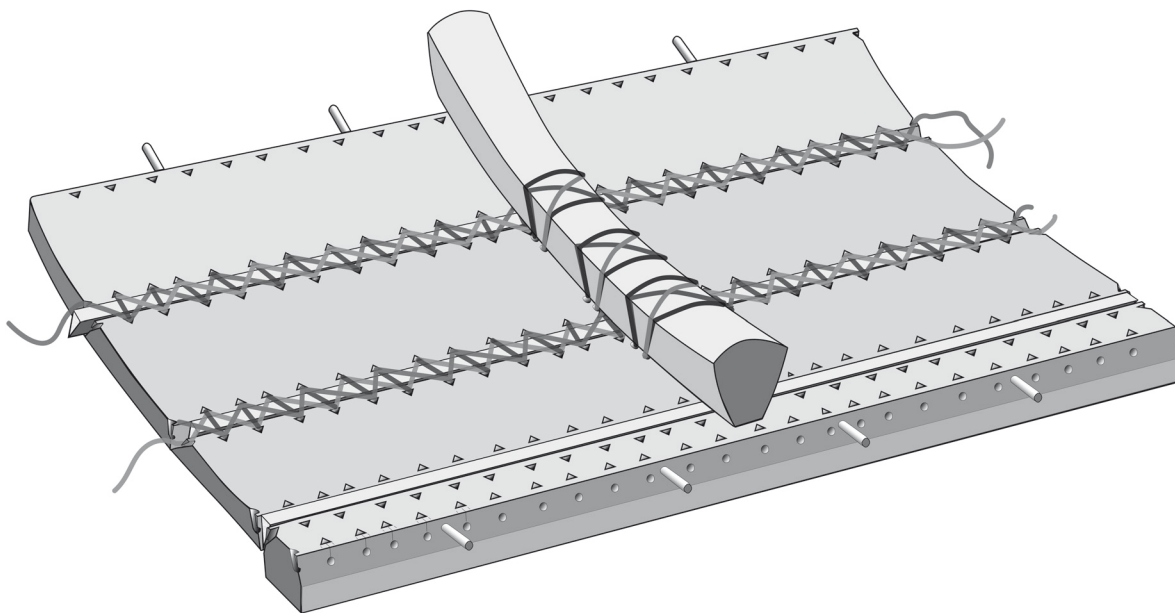

Sl. 28: Poznoarhajska ladja Marseille Jules-Verne 9. Konstrukcijske značilnosti.  
 Fig. 28: Late Archaic Marseille Jules-Verne 9 ship. Construction features.  
 (Po / After Pomey 1997, Fig. 5)

odkriti ladji iz zaliva pri Zambratiji na zahodni obali Istre, datirani v začetek ali prvo polovico 1. tisočletja pr. n. št.,<sup>56</sup> se je najdlje ohranilo v Dalmaciji in na severnem Jadranu ter na celinskih vodah v njegovem zaledju.<sup>57</sup> Giulia Boetto in Corrine Rouse sta opozorili, da je vzorec šivanja ladje iz Lip drugačen in preprostejši od navzkrižnega šivanja, ki se pojavlja pri morsko-lagunarnih (npr. Valle Ponti/Commachio)<sup>58</sup> in rečnih plovilih (npr. Stella pri Prečenu/Precenicco)<sup>59</sup> t. i. rimsko-padske tradicije, dodatno označene z uporabo tehnike spajanja na pero in utor v zgornjih delih školjke ter spajanjem ogrodja z oplato z lesenimi klini in šivanjem. Ladja iz Lip naj bi po mnenju avtoric sodila v t. i. rimsko-ilirsko tradicijo, za katero so značilni cikcak in diagonalno šivanje ter prevladujoča uporaba lesenih moznikov. Slednji sta, poleg ladje iz Zambratije, prisodili še vse tri ladijske razbitine iz Zatona pri Ninu (1. st. n. št.)<sup>60</sup> in ladjo iz Caske na Pagu (1.–2. st. n. št.).<sup>61</sup> Ime tradicije, ki s pristikom ilirska implicira

njen predrimski izvor, poleg ladje iz Zambratije, utemeljujejo tudi antični literarni viri, ki šivanje omenjajo kot ladjedelniško tehniko, značilno za Histre in Liburne<sup>62</sup> (glej tab. 2).

Novoodkrito plovilo iz Sinje Gorice (glej sl. 10) kaže v primerjavi z ladjo iz Lip nekaj izrazitih tehnoloških razlik, ki na eni strani nakazujejo nadaljnji razvoj regionalne gradnje tovornih plovil, na drugi pa doslej **nepoznani tip ogrodja v obliki vitkih talnih tramičev**, umaknjenih v utor v platicah in segajočih skozi stene čolnic. V tej fazi raziskav ni mogoča natančna določitev oblike preseka (pravokoten, trapezast oz. grebenast?) niti preveritev možnosti, da sta bila tramič in utor po dolžini blago konusno oblikovana, kar bi zagotovilo dodatno trdnost spoja.

Obravnavana konstrukcija, ki, kot napisano, ni bila nujno uporabljena po celotni dolžini plovila oz. so jo morda kombinirali z drugačnim ogrodjem, spominja na lastovičjo vez, zelo staro tesarsko rešitev, ki so jo poznali že v predkovinskih obdobjih evropske prazgodovine. Potrjena je na kolesih vozov iz časa med neolitikom in železno dobo, pri katerih so posamezne kolesne plošče povezali z dvema ali več prečnimi letvami trapezastega preseka, med drugim pri bakrenodobnem kolesu z območja koliščarske naselbine Stare gmajne pri Verdu.<sup>63</sup>

<sup>56</sup> Koncani Uhač, Uhač 2012.

<sup>57</sup> Beltrame 2000; Marlier 2002; Beltrame, Gaddi 2013, 300–303, sl. 1.

<sup>58</sup> Berti 1990.

<sup>59</sup> Vitri et al. 2001; Fozzati, Capulli, Castro 2012.

<sup>60</sup> Brusić, Domjan 1985; Gluščević 2004.

<sup>61</sup> Radić Rossi, Boetto 2011.

<sup>62</sup> Boetto, Rouse 2011, 187–188, sl. 9; 2012.

<sup>63</sup> Velušček, Čufar, Zupančič 2009, 203–205.

Tab. 2: Tehnološke značilnosti skupine šivanih ladij iz srednjega in severnega Jadrana ter njim sorodnih ladij iz zaledja.  
 Tab. 2: Technological features ... (see Translation)

Najdišče (Datacija)	Okolje uporabe	Oblika trupa		Spajanje platic				Spajanje ogrodja z oplato			Čolnica	Snov	
		Prečni preseki	Tloris	Šivanje (v cm)	Mozniki	Pero in utor	Spojke (Razmik)	Vrvi/ pletence	Mozniki	Žebli		Oplata	Ogrodje (razmik v cm)
<b>Zambratija</b> (prva pol. 1. tisočletja pr. n. št.)	morje	zaobljen	elipsoiden	diagonalno (5)				+				<i>Ulmus</i> sp.	<i>Alnus</i> sp. (?)
<b>Caska</b> (1.–2. st. n. št.)	morje	zaobljen	elipsoiden	diagonalno (2–2,5)					+			<i>Fagus</i> sp.	<i>Quercus</i> sp. (39,5)
<b>Zaton 1</b> (1. st. n. št.)	morje	zaobljen	elipsoiden	diagonalno (2–2,5)					+				(33–45)
<b>Zaton 2</b> (1. st. n. št.)	morje	zaobljen	elipsoiden	diagonalno (2–2,5)					+				(13–20)
<b>Zaton 3</b> (1. st. n. št.)	morje	zaobljen	elipsoiden	diagonalno (2–2,5)					+				(32,7–41)
<b>Stella</b> (prva pol. 1. st. n. št.)	morje- laguna- reka	zaobljen z ravnim dnom	elipsoiden	križno (2,5)		+			+			<i>Ulmus</i> sp., <i>Quercus</i> sp.	<i>Quercus</i> sp. ? (ca 25)
<b>Valle Ponti- Comacchio</b> (avgust. obdobje)	morje- laguna- reka	zaobljen z ravnim dnom	elipsoiden	križno (2,5)		+		+	+			<i>Ulmus</i> sp.	<i>Quercus</i> sp. (45)
<b>Lipe</b> (konec 1. st. pr. n. št.–zač. 1. st. n. št.)	reka	ravno dno	elipsoiden	cik-cak? (8–10)	+	17			+	+	C	<i>Picea</i> sp.	<i>Quercus</i> sp., <i>Ulmus</i> sp. (60)
<b>Sinja Gorica</b> (zač. 1. st. n. št.)	reka	ravno dno	elipsoiden				18–25			+	L	<i>Fagus</i> sp.	<i>Ulmus</i> sp., <i>Fagus</i> sp., <i>Abies</i> sp. (?)
<b>Sisak</b> (3. st. n. št.)	reka	ravno dno	poli- gonalen				7–10		+		L	<i>Quercus</i> sp.	<i>Quercus</i> sp. (55–60)

V ladjedelnstvu je sorodna tehnološka rešitev znana pri plovilih bronaste in starejše železne dobe atlantske Evrope, in sicer pri ladjah Dover (okoli 1575–1520 pr. n. št.), Ferriby 1 (okoli 1390–1130 pr. n. št.) in Brigg (okoli 410–350 pr. n. št.), pri katerih so bile talne platice poleg šivanja v tehniki kontinuiranega šiva ali s samostojnimi zankami spojene še s prečnimi zagozdami, zataknenjimi skozi luknje v masivnih čokih, ki so bili izdelani iz nepotesanih delov platic. Tako je bila zagotovljena trdnost talne oplate v prečni smeri, pa tudi njihova poravnava po vzdolžni in navpični osi, kar je zmanjšalo delovanje strižnih sil na stike med platicami.<sup>64</sup>

Razmik med obema dokumentiranima tramičema ladje iz Sinje Gorice je med 1,78 in 1,82 m, kar ustreza 6 rimskim čevljem (1,78 m) in nakazuje uporabo metričnih pravil. Tramiči so bili na platice pritrjeni z 8,1 do 12,5 cm dolgimi **železnimi žebli**, ki so bili zabiti poševno v različnih smereh ter so po obliki in dimenzijah podobni žebli, uporabljenim pri ladji iz Lip.<sup>65</sup> Na opazovanem delu ladje ni bilo mogoče ugotoviti, ali segajo skozi celotno debelino platic ali ne. Prvo možnost podpira 11,5 cm dolg žebelj s kratko zakrivljeno konico (glej *sl. 19*: PN 6; *t. 3*: 18), ki je prosto ležal na tramiču FT 1. Uporaba lesenih mozničkov ni dokazana, kar ladjo iz Sinje Gorice loči tako od ladje iz Lip kot od tiste iz Kolpe v Sisku (*sl. 29*; 30), pri katerih je bilo ogrodje na oplato pritrjeno večinoma oziroma izključno z moznički. Pri ladji iz Lip so železne žeblje uporabili le za pritrjevanje desk na talne tramiče,<sup>66</sup> čez oplato pa je sodeč po Müllnerjevi dokumentaciji segalo le nekaj žeblijev, katerih konice so zatolkli na spodnje površine platic.<sup>67</sup> Gradnjo tovornih ladij rimsko-keltske tradicije iz Galije in Porenja nasprotno označuje množična uporaba železnih žeblijev (*sl. 31*), ki so bili praviloma zabiti od znotraj navzven skozi vnaprej izvrtane luknje v ogrodju in oplati, pri čemer so presegaajoče konice dvakrat ukrivili in zabili v les.<sup>68</sup> Pri ladjah skupine Rhône-Saône (podskupina I) so bile talne platice pribite na elemente ogrodja od zunaj navznoter in v obratni smeri, pri podskupini II, pri kateri so bili spoji med talnimi platicami izvedeni v tehniki na

—→

*Sl. 29*: Tloris ladijske razbitine iz Kolpe v Sisku po tlorisni in fotografski dokumentaciji zaščitnih raziskav leta 1985. Presek a–a” je v zmanjšanem merilu.

*Fig. 29*: Ground plan of the shipwreck from the Kolpa river at Sisak, after the ground plan and photographic documentation from the 1985 rescue investigation. Cross section a–a” is in a smaller scale.

pero in utor, pa samo od znotraj navzven.<sup>69</sup> Izdatna uporaba kovinskih žeblijev je potrjena tudi pri maloštevilnih sredozemskih ladjah klasičnega in zgodnjehelenističnega obdobja, vendar jo je pozneje povsem izpodrinilo spajanje ogrodja z oplato z lesenimi moznički in s posamično zabitimi železnimi ali bronastimi žebli.<sup>70</sup>

Iz enega kosa lesa iztesana **čolnica**, ki je zagotavljala neprekinjen prehod ladijskega dna v boke, je poleg prevladujoče uporabe lesa hrasta ter spajanja oplate in ogrodja z železnimi žebli eden od najprepoznavnejših elementov rimskodobnih tovornih ladij rimsko-keltske tradicije na celinskih vodah med južno Francijo in spodnjim Podonavjem. Bolj odprta zasnova tovornih ladij s poševnimi boki v nagibu okoli 20 do 35 stopinj od navpične osi, značilna za plitvejšje ladje s tekočo oplato (npr. Lipe, Lyon-Place Tolozan), je pogojevala čolnice s presekom v obliki črke C, praviloma globlje zasnovane ladje s čolnicami v obliki črke L pa vključujejo tako plovila s tekočo bočno oplato (Bevaix, Pommeroeul 2, Yverdon-les-Bains 1, Sisak, Sinja Gorica)<sup>71</sup> kot ladje, pri katerih so boki nad čolnico zvišani v tehniki klinker in ki se pojavljajo samo v porenški skupini. Nasprotno je bil prehod dna v boke pri tovornih ladjah skupine Rhône-Saône izveden ali z masivno polovico debela, pribito na zunanjo platico in rebra (podskupina I), ali z rešitvijo, pri kateri je bila spodnja bočna platica pribita na stranski rob zunanje talne platice (podskupina II).<sup>72</sup>

Druga posebnost ladje iz Sinje Gorice so številne **železne spojke**, ki so bile v neenakomernih razmikih, katerih težišče leži v skupini 18 do 25 cm, zabite čez stike platic na notranji strani plovila, nekaj spojke pa je bilo dokumentiranih tudi na spodnji strani dna in na zunanji strani bokov. Vsaj na notranjem delu oplate so bile spojke umaknjene v vnaprej izdelane utore, kar spominja na rešitev

<sup>64</sup> McGrail 2001, 184–191.

<sup>65</sup> Gaspari 1998a, 201, sl. 21: 15–20.

<sup>66</sup> Glej sledove štirih žeblijev na enem koncu ohranjenega dela oplate ladje iz Akvileje-Canale Anfora 2005, ki bi pogojno lahko nakazovale pritrdišče za rebro/tramič (Beltrame, Gaddi 2013, 299).

<sup>67</sup> Gaspari 1998a, 202.

<sup>68</sup> Bockius 2000, 453.

<sup>69</sup> Guyon, Rieth 2011, sl. 4.

<sup>70</sup> Bockius 2000, 453.

<sup>71</sup> Bockius 2000, 471.

<sup>72</sup> Guyon, Rieth 2011, 98–99.



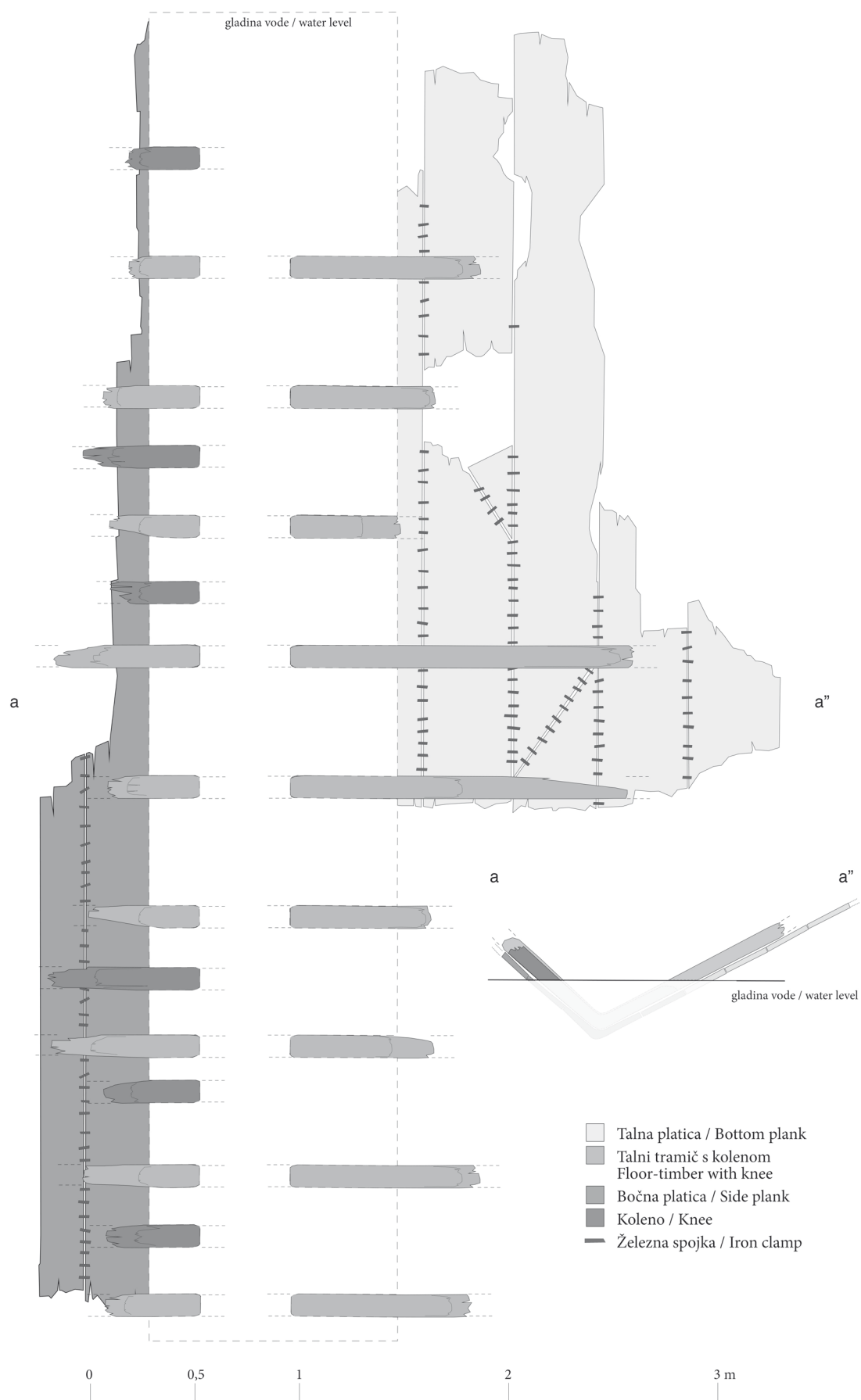

za zaščito vrvi pri šivanih plovilih, kjer so bili vhodi v luknje na izpostavljenem zunanjem delu oplate oblikovani kot polkrožne, trapezoidalne ali pravokotne izdolbine v robovih platic.<sup>73</sup>

Edini primerjavi za tako tehniko spajanja platic in utrjevanja tesnila s spojkami sta znani z manjše ladje z obrežja Donave na območju kastela *Aquae* pri Kušjaku pri Prahovem v Železnih vratih<sup>74</sup> in sekundarno uporabljene razbitine tovarne ladje z območja nakladalne ploščadi na lokaciji "Kovnica" v strugi Kolpe v Sisku (*sl.* 29).<sup>75</sup> Pri celinskih tovornih ladjah iz galskih in germanskih provinc podobna ureditev ni znana, so pa bile na nekaterih tovornih ladjah iz Porenja (npr. Zwammerdam 2, Yverdon-les-Bains 1, Woerden 7) in pri dveh patroljnih ladjah iz Oberstimma na bavarskem delu Donave (začetek 2. st. n. št.) podobne spojke posamično uporabljene pri utrjevanju posameznih delov, pri manjših popravilih ali pa za učvrstitev tesnila, ki je bilo praviloma nabito v posebej pripravljen presledek med platicami šele po njihovi vgradnji.<sup>76</sup>

Pri ladji iz Kušjaka, okvirno datirani v trajansko obdobje, so bile železne spojke dokumentirane v razmikih 5 do 10 cm na notranji strani vzdolž nekaterih stikov med talnimi in bočnimi platicami, vendar je v nasprotju z ladjo Sisak zaporedje spojk ponekod prekinjeno. Pri ladji iz Siska (*sl.* 29; 30), ki je bila domnevno zgrajena okrog sredine 3. st. n. št., so jih uporabili za celotno oplato, in sicer so bile zabite pravokotno ali rahlo poševno čez vzdolžne in prečne stike hrastovih platic vsakih 4 do 7 cm narazen. Spojke, ki ne presegajo 5 cm dolžine, so zelo podobne primerkom, uporabljenim pri ladji iz Sinje Gorice, med katerimi prevladujejo spojke z dolžino 3,9 do 6 cm. Podobne so tudi dimenzije platic, ki so pri ladji iz Siska široke od 25 do 40 cm in debele okoli 6 cm, obe ladji pa povezuje tudi uporaba tesnila iz rastlinskega materiala.

Pri razbitini iz Siska (*sl.* 29), od katere se je ohranil okoli 7 m dolg in 2,5 m širok del dna z enim od bokov ohranjene višine 1,1 m, so ogrodje sestavljali masivni, 55 do 60 cm razmaknjeni hrastovi tramiči pravokotnega preseka, med katerimi sta bili ob vsakem od bokov vgrajeni po dve kolenasti rebri iz naravno ukrivljenega lesa. Po beležkah vodje zaščitnih raziskav l. 1985 (*sl.* 30) je bil prehod dna v skoraj navpični stranici izveden s čolnicami s presekom v obliki črke L, pri



*Sl.* 30: Tramiča in talne platice ladje iz struge Kolpe v Sisku med izkopavanjem leta 1985.

*Fig.* 30: Timbers and bottom planks of the ship from the riverbed of the Kolpa at Sisak during the 1985 excavation. (Foto / Photo: K. Kiš, Gradski muzej Sisak, No. III-4327).

katerih je bila notranja stran polkrožno iztesana, torej podobno kot pri ladji iz Sinje Gorice.

Po obliki, značilnostih konstrukcije ter izbiri lesa se ladja iz Siska približuje tovornim ladjam iz galskih in germanskih provinc, vendar je brez dvoma izdelek regionalne tradicije s tehnološkimi koreninami na severnem Jadranu in njegovem zaledju. Temeljni argument za to trditev je razmestitev spojk, ki spominja na intervale med luknjami v robovih platic šivanih ladij, na kar je opozoril že Ronald Bockius v obravnavi ladje iz Kušjaka, pri ladjah iz Sinje Gorice in Siska pa je ta podobnost še očitnejša. Sredozemski praksi ustrezajo tudi izključna uporaba lesenih moznikov za pritrjevanje ogrodja na oplato, razmestitev in poševni stiki platic v vzdolžnih nizih, izmenično razporejeni tramovi in rebra ter zlasti trikotni utori, iztesani v spodnjih stranicah tramov na mestih, kjer so ti prečkali stike med platicami. To posebnost, ki je na istih mestih potrjena tudi pri nekaterih ladjah porenske skupine (npr. Zwammerdam 2, De Meern 1 in 4, Woerden 7),<sup>77</sup> so nekateri intepretirali kot odprtine za pretok kaluže, prezračevanje oziroma način za omejevanje propadanja reber nad stiki, vendar gre verjetneje za tesarski podpis brez večje

<sup>73</sup> Beltrame 2000, 93.

<sup>74</sup> Bockius 2001.

<sup>75</sup> Gaspari, Erič, Šmalcelj 2006.

<sup>76</sup> Bockius 2002b, 52–54; Holk 2011, 39.

<sup>77</sup> Bockius 2000, 455, 465, 468.

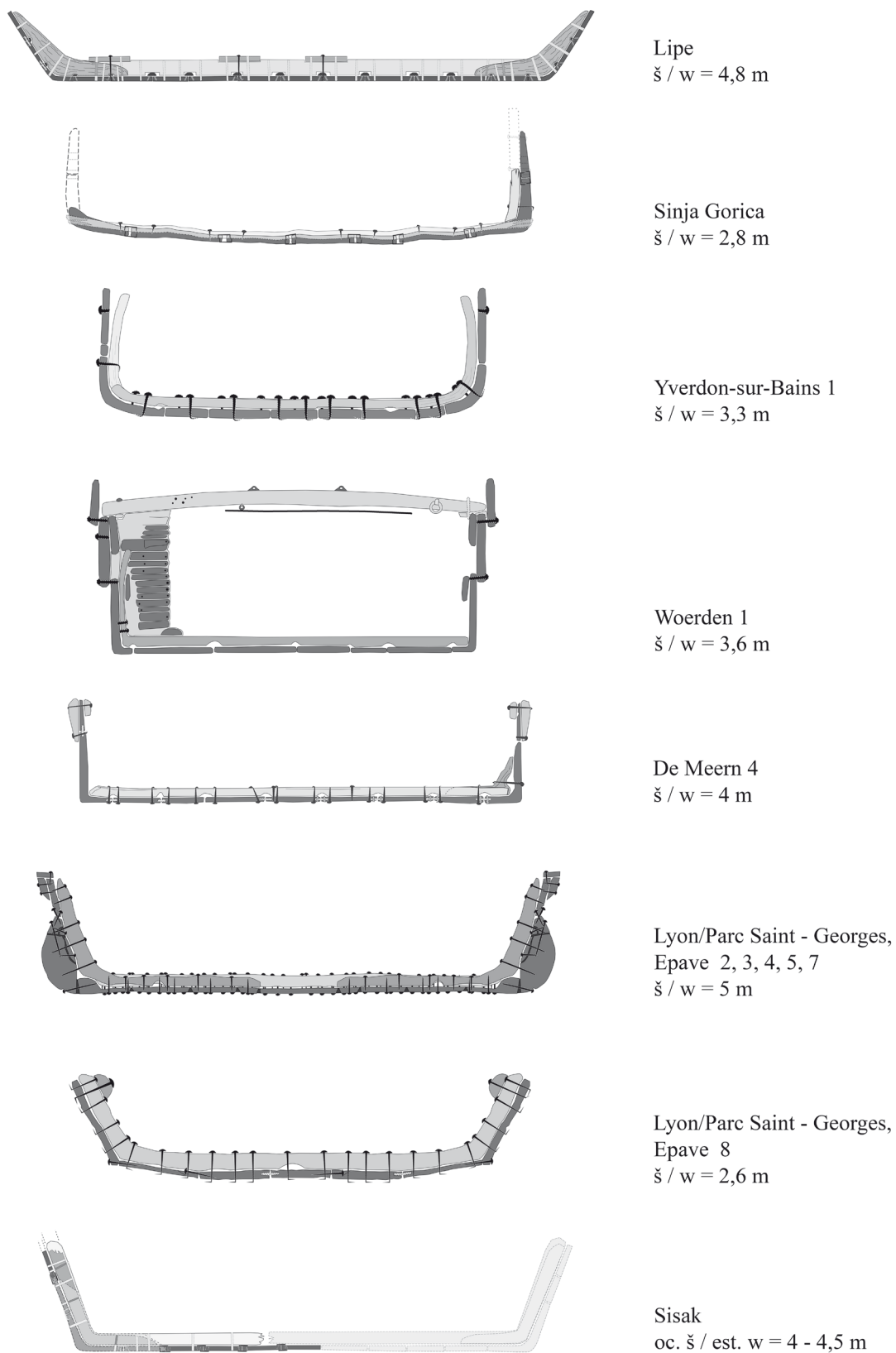

Sl. 31: Preseki rimskih tovornih ladij z različnih najdišč. Preseki niso v enakem merilu.

Fig. 31: Cross sections of Roman cargo ships from various sites. Cross sections are not to scale.  
(Po / After: Müllner 1892 [Lipe]; Bockius 2000 [Yverdon, Woerden 1]; Bockius 2011 [De Meern 4];  
Guyon, Rieth 2011 [Lyon/ParcSaint-Georges]; preseki / cross sections: M. Erič).

praktične vrednosti, ki je spominjal na tehnološko nujnost pri šivanih ladjah, pogojeno s snopi tesnilnega materiala.<sup>78</sup>

Med **vrstami lesa**, ki so jih uporabili pri gradnji ladje iz Sinje Gorice, preseneča prevlada bukve, saj se ta drevesna vrsta v antičnem in tradicionalnem pomorskem tesarstvu Sredozemlja skoraj ne pojavlja.<sup>79</sup> Plinij starejši bukovino in orehovino uvršča med lesne vrste, primerne za podvodne in podzemne gradnje, in izrecno omenja njeno slabšo odpornost (*N. h.* XVI 79). Podobno se lastnosti bukovine opisujejo tudi v tradicionalnem gospodarstvu, pri čemer se trpežnost svežega, neposušena bukovega lesa v vodi primerja z macesnovim.<sup>80</sup>

Pri morskih plovilih antičnega Sredozemlja je bil za oplato najpogosteje uporabljen les iglavcev, zlasti različnih vrst bora, cedre in jelke, redkeje smreke. Uporaba lesa listavcev za izdelavo celotne oplate je očitno regionalna posebnost, saj se pojavlja tudi pri nekaterih šivanih ladjah. Primer oplate iz bukovine je dokumentiran prav pri okoli 9 m dolgi šivani ladji iz Caske,<sup>81</sup> pri ladji iz Zambratije in večini rimskodobnih šivanih plovil iz območja vzdolž obal Benečije in Furlanije-Juljske krajine (npr. Stella, Aquileia-Canale Anfora, San Francesco del Deserto in Valle Ponti-Comacchio) pa je bil v ta namen uporabljen odpornejši jesenov les. Izbira bukovine za ladjo iz Sinje Gorice in lahke smrekovine, ki jo je težko obdelovati in v vodi ni posebej trajna, za platice ladje iz Lip dokazuje uporabo lokalno razpoložljivih drevesnih vrst z rastišč v okolici Ljubljanskega barja.

**Tesnjenje** z bukovino oz. rastlinskim gradivom pri ladji iz Sinje Gorice je konstruktorski podpis sredozemskega izvora. Pri šivanih plovilih iz srednje in severne Dalmacije so bili v ta namen najpogosteje uporabljeni snopi lipovega ličja in ovijalk (?), za šivalne vrvi pa lan in žuka oz. brnistra (*Spartium junceum L.*). Za skupino rimsko-keltskih ladij iz Porenja je značilno tesnjenje z mahom, travami ali drevesnimi vlakninami,<sup>82</sup> za skupino Rhône-Saône pa s tkanino, namočeno v smolo.<sup>83</sup>

V okviru tovornih ladij z ravnim dnom se **elipsasta oblika z bolj ali manj prisekanima koncema** poleg obeh ladij z Ljubljanskega barja pojavlja pri

nekaterih rečnih oziroma jezerskih ladjah skupine Rhône-Saône in geografsko sosednje alpske skupine. Skoraj identična krivina vodne linije, ki je bila ugotovljena pri ladjah iz Lip, ladjah Yverdon-les-Bains 1 in Arles-Rhône 3 in se domneva tudi za ladjo iz Sinje Gorice, bi lahko nakazovala upoštevanje določenih pravil, ki so izhajala iz potrebe po zagotavljanju optimalnega razmerja med namenom (nosilnost in vrsta tovora), plovniimi lastnostmi in načinom premikanja ter verjetno tudi z določenim ozirom na v sredozemskem ladjedelništvu običajno elipsasto-koničasto obliko ladij s tekočo oplato. Ta je tudi tovornim ladjam z ravnim dnom zagotavljala boljše plovne lastnosti, tj. večjo hitrost oziroma manjšo potrebno gonilno silo in boljšo sposobnost manevriranja, kot so jih imela oglata plovila porenske skupine (*barques polygonales* tipa A3 po B. Arnoldu).<sup>84</sup> Širok trup z globokim ugrezom mora razumljivo odrivati več vode kot ozek trup z majhnim ugrezom, kar zavira plovbo, poleg turbulence, ki nastaja ob obtekanju trupa, pa k skupnemu hidrodinamskemu uporu plovila prispevajo tudi vrtinci, ki nastajajo zaradi vdiranja vode v območje nižjega tlaka tik za krmo, kar je glavni razlog za koničasto obliko krmnega dela plovil (vsaj pod vodno gladino).<sup>85</sup>

Ob predpostavljenejem ujemanju vodnih linij ladje iz Sinje Gorice in ladje iz Lip, ki se po **razmerju med širino in dolžino** (okoli 1: 6,4; d. okoli 28,7 m; š. 4,5 m) najbolj približuje ladjama Zwammerdam 6 in Woerden 7,<sup>86</sup> smemo za prvo glede na dokumentirano širino (2,47 do 2,88 m) in višino (0,65 m) domnevati okoli 20 m dolgo in 3 m široko plovilo z okoli 0,7 m visokimi stranicami. Domnevna velikost plovila ima med ladjami skupine Rhône-Saône primerjave v okoli 2,8 m širokih ladjah Lyon/Parc Saint-Georges 2 in 8, datiranih v 55 n. št. oziroma 210–215 n. št.,<sup>87</sup> pri katerih je ocenjena dolžina med 18 in 25 m. Med ladjami porenske skupine omenjenim dimenzijam ustrezajo npr. ostanki skoraj 3 m široke in 0,67 m visoke ladje iz rimskega pristanišča na reki Haine v Pommeroeulu (Belgija), datirane v drugo polovico 1. st. ali zgodnje 2. st. n. št.,<sup>88</sup> in ladja iz nekdanjega meandra reke Waal pri kraju Druten (Nizozemska), datirana na konec 2. ali začetek 3. st. n. št., od katere se je ohranil 16 m

<sup>78</sup> Glej Bockius 2011, 54–55.

<sup>79</sup> Rival 1991, 64–66, 86, tab. 4.

<sup>80</sup> Zalokar 1854, 302, 309.

<sup>81</sup> Radić Rossi, Boetto 2001, 509.

<sup>82</sup> Bockius 2002a, 208–213, tab. 1–2.

<sup>83</sup> Guyon, Rieth 2011, 98–100.

<sup>84</sup> Arnold 1992, 73–74.

<sup>85</sup> K fiziki plovbe glej npr. Anderson 2003.

<sup>86</sup> Holk 2011, 39.

<sup>87</sup> Guyon, Rieth 2011, 94.

<sup>88</sup> Boe 1978, 25–27.

dolg del, širok od 2,8 m na sredini do 1,72 m na koncu.<sup>89</sup> Posamezne v celoti ohranjene ladje, kot sta Arles-Rhône 3, datirana v sredino 1. st. n. št., ki pri širini blizu 3 m meri v dolžino okoli 31 m (razmerje pribl. 1: 10,5),<sup>90</sup> ali 24,7 m dolga in 2,7 m široka ladja Vleuten-De Meern 1 (razmerje pribl. 1: 9,1), zgrajena l. 148 n. št., opominjajo, da je uporaba indeksacije pri rekonstrukcijah dolžin podobnih tovornih plovil lahko le okvirna.

**Tovorna zmogljivost** ladje iz Lip zelo verjetno nikoli ni bila izkoriščena do teoretične nosilnosti, ki je pri ugrezu 0,4 m ocenjena na skoraj 40 ton.<sup>91</sup> Njeno **namembnost** morda nakazujeta oba vzdolžna pasova talnih desk, ki sta domnevno olajševala natovarjanje lesenih sodov. V sočasnih kontekstih so med sodi najpogostejši primerki skupine z višino od 1,9 do 2 m, kar ustreza širini tovornega prostora na ladji.<sup>92</sup> Razsuti in bolj grob tovor pri ladji iz Lip skoraj ne pride v poštev, saj bi lahko njegovo nasipanje ali čiščenje poškodovalo razmeroma tanke smrekove platice (debelina 3,5 do 4 cm) in razrahljalo šive. Pri ladjah Arles-Rhône 3 in Woerden 1 je bil osrednji del opremljen z lesenim opažem, pritrjenim na talne tramiče in bočna kolena, kar omogoča sklepanje, da gre za prostor za v vrečah shranjen živež ali drugo blago, ki ni smelo priti v stik s kalužo.<sup>93</sup> Opisana ureditev raziskanega dela ladje iz Sinje Gorice, ki na dokumentiranem delu razen potencialnega utora za prekatno steno ne izkazuje talnih elementov ogrodja, bi lahko nakazovala tovor z manjšo težo in večjim volumnom, manj občutljiv za vlago oz. mokroto (npr. pesek, glina, opeka ipd.), morda pa gre za, kot pri ladji Vleuten-De Meern 1, kabini ali kuhinji namenjen prostor, ki so ga od preostalega dela ladje ločile premične predelne stene.

*Gaspari*

## 8. SKLEP

Glede na enako namembnost in podoben videz obeh načinov predhodnega spajanja platic in utrjevanja tesnila ter geografsko lego omenjenih odkritij iz Ljublanice pri Sinji Gorici, Kolpe v Sisku in Donave pri Kušjaku se zdi verjetno, da gre pri železnih spojkah za tehnološko rešitev, ki je očitno že zelo zgodaj, najpozneje pa v avgustejskem obdobju začela nadomeščati zahtevno in zamudno tehniko šivanja ter jo na celinskih vodah črnomskega povodja kmalu verjetno popolnoma izpodrinila. Vzgib za to spremembo je najverjetneje prišel iz povečanih logističnih zahtev vojaške oskrbe, kar nakazuje tudi starost novoodkritega plovila iz Ljublanice. Glede na njeno sočasnost z ladjo iz Lip gre zelo verjetno za izdelek tesarjev, ki so obvladali oziroma vsaj poznali obe tehniki, šivanje in spajanje s spojkami.

Ladja iz Siska, najverjetneje namenjena prevozu težjega in okornega tovara, nakazuje, da so ekonomski razlogi regionalno prakso v teku cesarskega obdobja usmerili h gradnji rigidnih tovornih ladij poligonalnega obrisa z masivnimi in rokodelsko manj dodelanimi konstrukcijskimi elementi in slabšimi plovnimi lastnostmi. Ne glede na to, ali gre za prometna sredstva rimske vojske, ki so bila pogosto pogodbeno prenesena v upravljanje zasebnih korporacij, ali javnemu transportu namenjene ladje, skoraj ni dvoma, da je bila gradnja teh zmogljivih plovil odgovornost vojaške uprave in izdelek legijam priključenih amfibijskih enot s kvalificiranim osebjem (*fabri navales*).<sup>94</sup>

<sup>89</sup> Lehmann 1990.

<sup>90</sup> Marlier 2011.

<sup>91</sup> Bockius 2000, sl. 33 in 34.

<sup>92</sup> Gaspari 1998a, 215.

<sup>93</sup> Bockius 2000, 478.

<sup>94</sup> Bockius 2000, 482–485.

## 9. KATALOG

(t. 1–4; seznam 1)

V Katalogu so predstavljeni konstrukcijski elementi: spojke in žebli. Vsi predmeti so iz železa, zato snov v nadaljevanju ni navedena (izjema je leseni bočni tramič ST 2, ki skupaj s pritrjenim žebljem predstavlja del najdbe PN 66 [t. 4]). Najdbe hrani Muzej in galerije mesta Ljubljane.

Vse mere so podane v cm.

T. 1:

– Najdbe, odkrite leta 2008, v bližnji okolici ladje, prostoležeče, dokumentirane in pobrane. Označene so s št. kvadranta in zaporedno št. najdbe (npr. 36–1).

T. 2–4:

– Najdbe, odkrite med dokumentiranjem leta 2012, prostoležeče, dokumentirane in pobrane. Označene so kot posebne najdbe (PN) in z zaporedno št. najdbe (npr. PN 1).

Seznam 1:

– Najdbe, odkrite med dokumentiranjem leta 2012, pritrjene na lesenem ogrodju ladje, ostale so *in situ*. Označene so s terensko oznako S (spojka) in z zaporedno št. najdbe (npr. S 34; glej sl. 15).

### Kratice / Abbreviations:

Št. na t. / No. on Pl. = Zaporedna št. na *tabli* / Successive Number on *Plate*

Dolž. / L. = Dolžina / Length

Šir. / W. = Širina / Width

Deb. / Th. = Debelina / Thickness

Viš. / H. = Višina / Height

Ohr. / Surv. = Ohranjeno / Surviving (%)

TO / FC = Terenska oznaka / Field code

Op. / Note = Opomba / Note

Pr. glave / Diam. of head = Premer glave / Head diameter

Erič

**Tabla 1 / Plate 1**

(Leto / Year 2008)

### ŽELEZNE SPOJKE / IRON CLAMPS

Št. na t. / No. on Pl.	Dolž. / L.	Šir. / W.	Deb. / Th.	Viš. / H.	Ohr. / Surv. %	TO / FC	Op. / Note
1	7,2	1,3	0,2	1,6	100	36-1	(KV 36)-1
2	6,7	1,2	0,2	2,1	100	36-2	
3	5,2	1,4	0,2	1,9	100	36-3	
4	5,4	1,4	0,2	2	100	37-1	
5	6,3	1,6	0,2	1,9	100	37-2	
6	7,1	1,7	0,2	1,4	100	37-3	
7	6,4	1,5	0,2	1,9	100	37-4	
8	6,8	1,5	0,2	1,3	100	37-5	
9	4,6	1,6	0,2	1,6	100	37-7	
10	6	1,4	0,2	2,2	100	37-8	
11	7,6	1,4	0,2	1,6	100	37-9	
12	6,3	1,4	0,2	2	100	37-10	
13	6,5	1,3	0,2	1,5	100	37-11	
14	5,3	1,3	0,2	2,1	100	37-12	
15	6,5	1,4	0,2	1,8	100	37-13	

### ŽELEZNI ŽEBLJI / IRON NAILS

Št. na t. / No. on Pl.	Dolž. / L.	Deb. / Th.	Pr. glavice / Head diam.	Ohr. / Surv. %	TO / FC	Op. / Note
16	9,2	0,5	1,5	100	37-17	
17	8,1	0,6	1,8	100	37-18	

**Tabla 2 / Plate 2**  
(Leto / Year 2012)

ŽELEZNE SPOJKE / IRON CLAMPS (Sl. / Fig. 16)

Št. na t. / No. on Pl.	Dolž. / L.	Šir. / W.	Deb. / Th.	Viš. / H.	Ohr. / Surv. %	TO / FC	Op. / Note
1	18,8	3,5	0,2	2,5	?	PN 3	
2	5	1,4	0,2	2,4	100	PN 7	
3	5	1,7	0,2	0,8	60	PN 8	
4	6,9	1,7	0,2	1,8	100	PN 9	
5	6,9	1,5	0,2	2,4	100	PN 10	
6	5,5	1,5	0,2	2,3	100	PN 12	
7	6,4	1,9	0,2	2,2	100	PN 13	
8	7,3	1,9	0,2	2,3	100	PN 14	
9	7,2	1,6	0,2	1,8	80	PN 15	
10	7,5	1,6	0,2	2,1	100	PN 17	
11	8,4	1,5	0,2	1,8	100	PN 18	
12	8,9	1,7	0,2	1,8	100	PN 19	
13	5,9	1,7	0,2	2	100	PN 21	
14	6,1	1,4	0,2	2,2	100	PN 23	
15	8,8	1,4	0,2	1,7	100	PN 29	
16	6,5	1,6	0,2	1,9	100	PN 30	
17	4,8	1,5	0,2	1,9	100	PN 31	
18	8,6	1,4	0,2	1,8	100	PN 32	
19	18,9	1,7	0,2	3,2	?	PN 33	Sl. / Figs. 15, 17
20	7,7	1,4	0,2	2,1	100	PN 34	

**Tabla 3 / Plate 3**  
(Leto / Year 2012)

ŽELEZNE SPOJKE / IRON CLAMPS (Sl. / Fig. 16)

Št. na t. / No. on Pl.	Dolž. / L.	Šir. / W.	Deb. / Th.	Viš. / H.	Ohr. / Surv. %	TO / FC	Op. / Note
1	10,3	1,5	0,2	1,6	100	PN 35	
2	4,6	1,7	0,2	2,8	100	PN 46	
3	7,5	1,8	0,2	2,6	100	PN 48	
4	7,7	1,7	0,2	2,1	100	PN 49	b. k.
5	6,8	1,4	0,2	1,8	100	PN 53	b. k.
6	6,3	1,4	0,2	2	100	PN 53	b. k.
7	9,6	1,7	0,2	1,4	100	PN 53	b. k.
8	8,4	1,4	0,2	2,2	100	PN 54	Sl. / Fig. 15
9	7,6	2,3	0,15	1,9	100	PN 57	
10	6,1	1,5	0,2	2,2	100	PN 59	b. k.
11	7,1	1,5	0,2	2	100	PN 60	b. k.
12	6,9	1,5	0,2	1,8	100	PN 61	b. k.
13	6,1	1,4	0,2	2,2	100	PN 62	b. k.
14	4,8	1,7	0,2	2,2	100	PN 63	b. k.
15	5,5	1,6	0,2	1,8	80	PN 64	b. k.
16	4,4	1,5	0,2	2,1	80	PN 65	b. k.

## ŽELEZNI ŽEBLJI / IRON NAILS (Sl. / Fig. 19)

Št. na t. / No. on Pl.	Dolž. / L.	Deb. / Th.	Pr. glave / Head diam.	Ohr. / Surv. %	TO / FC	Op. / Note
17	12,5	0,8	?	80	PN 4	
18	11,5	0,5	1,7	100	PN 6	
19	8,6	0,7	1,7	100	PN 67	lega / position: FT 1; b. k.

Tabla 4 / Plate 4

(Leto / Year 2012)

POSEBNA NAJDBA / SMALL FIND PN 66

## BOČNI TRAMIČ / SIDE TIMBER ST 2 (Sl. / Fig. 13)

Št. na t. / No. on Pl.	Viš. / H.	Stanje / Condition	TO / FC	Op. / Note
1	45	( $u_{\max}$ ) ( $MC_{\max}$ ) 690 %	PN 66	PN 66 (= ST 2)*; vrsta lesa / wood species: <i>Abies Alba</i>

## ŽELEZNI ŽEBELJ / IRON NAIL (Sl. / Fig. 19)

Št. na t. / No. on Pl.	Dolž. / L.	Deb. / Th.	Pr. glave / Diam. of head	Ohr. / Surv. %	TO / FC	Op. / Note
2	12,5	0,8	1,8	80	PN 66	lega / position: ST 2

\* Bočni tramič ST 2 je bil najverjetneje poškodovan oz. obsekan zato, da bi ga bilo mogoče ločiti od čolnice CG 2 / Side Timber 2 was most probably damaged or cut so as to be detached from Chine-girder 2.

b. k. = brez koordinat / without coordinates

$u_{\max}$  = Napojitvena vlažnost lesa /  $MC_{\max}$  = Maximum Moisture Content

## Seznam / List 1

Najdbe, ki so ostale *IN SITU* / Finds left *IN SITU*

(Leto / Year 2012)

## ŽELEZNE SPOJKE / IRON CLAMPS (Sl. / Fig. 15)

Kat. št. / Cat. No.	Dolž. / L.	Šir. / W.	Deb. / Th.	Viš. / H.	Ohr. / Surv. %	TO / FC	Op. / Note
1	5,6	1,7	0,2	?	100	S 1	
2	7,2	1,5	0,2	?	100	S 2	
3	7,1	1,7	0,2	?	100	S 3	
4	7,2	1,6	0,2	?	100	S 4	
5	7,6	1,5	0,2	?	100	S 5	
6	6,1	1,5	0,2	?	100	S 6	
7	4,8	1,4	0,2	?	100	S 7	
8	6,8	1,5	0,2	?	100	S 8	
9	7,9	1,6	0,2	?	100	S 9	
10	6,8	1,4	0,2	?	100	S 10	
11	7,2	1,8	0,2	?	100	S 11	



Kat. št. / Cat. No.	Dolž. / L.	Šir. / W.	Deb. / Th.	Viš. / H.	Ohr. / Surv. %	TO / FC	Op. / Note
12	6,2	1,8	0,2	?	100	S 12	
13	5,9	1,4	0,2	?	100	S 13	
14	7,7	1,6	0,2	?	100	S 14	
15	6,7	1,6	0,2	?	100	S 15	
16	6,2	1,7	0,2	?	100	S 16	
17	6,3	1,9	0,2	?	100	S 17	
18	8,4	1,7	0,2	?	100	S 18	
19	6,2	1,5	0,2	?	100	S 19	
20	7,3	1,8	0,2	?	100	S 20	
21	6,6	1,7	0,2	?	100	S 21	
22	7,1	1,5	0,2	?	100	S 22	
23	6,3	1,6	0,2	?	100	S 23	
24	5,2	1,7	0,2	?	100	S 24	
25	6,5	1,7	0,2	?	100	S 25	
26	6,3	1,4	0,2	?	100	S 26	
27	7,1	1,4	0,2	?	100	S 27	
28	5,7	1,7	0,2	?	100	S 28	
29	5,1	1,4	0,2	?	100	S 29	
30	3,9	1,7	0,2	?	100	S 30	
31	6,9	1,5	0,2	?	100	S 31	
32	8,6	1,6	0,2	?	100	S 32	
33	5,8	1,5	0,2	?	100	S 33	
34	7,2	1,7	0,2	?	100	S 34	
35	7,3	1,7	0,2	?	100	S 35	
36	5,1	1,6	0,2	?	100	S 36	
37	7,9	1,4	0,2	?	100	S 37	
38	6,3	1,8	0,2	?	100	S 38	
39	7,4	1,6	0,2	?	100	S 39	
40	7,6	1,5	0,2	?	100	S 40	
41	6,7	1,9	0,2	?	100	S 41	
42	7,1	1,9	0,2	?	100	S 42	
43	6,1	1,8	0,2	?	100	S 43	
44	7,2	1,8	0,2	?	100	S 44	
45	7,5	1,7	0,2	?	100	S 45	
46	6,8	1,8	0,2	?	100	S 46	
47	8,1	1,7	0,2	?	100	S 47	
48	7,1	1,9	0,2	?	100	S 48	
49	6,7	1,8	0,2	?	100	S 49	
50	6,2	1,8	0,2	?	100	S 50	
51	?	1,7	0,2	?	20	S 51	
52	6,8	1,6	0,2	?	0	S 52	ocena / estimate
53	5,4	1,7	0,2	?	0	S 53	ocena / estimate
54	5,8	1,9	0,2	?	0	S 54	ocena / estimate
55	7,2	1,9	0,2	?	100	S 55	
56	7,1	1,7	0,2	?	100	S 56	

## ŽELEZNI ŽEBLJI / IRON NAILS (Sl. / Fig. 19)

Kat. št. / Cat. No.	Dolž. / L.	Deb. / Th.	Prem. glave / Head diam.	Ohr. / Surv. %	TO / FC	Op. / Note
57	?	?	1,5	100	Z1	
58	?	?	1,6	100	Z2	
59	?	?	1,5	100	Z3	
60	?	?	1,5	100	Z4	

Kat. št. / Cat. No.	Dolž. / L.	Deb. / Th.	Prem. glave / Head diam.	Ohr. / Surv. %	TO / FC	Op. / Note
61	?	?	1,7	100	Z5	
62	?	?	1,7	100	Z6	
63	?	?	1,8	100	Z7	
64	?	?	1,6	100	Z8	
65	?	?	1,7	100	Z9	
66	?	?	1,6	100	Z10	Sl. / Fig. 20
67	?	?	1,7	100	Z11	Sl. / Fig. 20
68	?	?	1,6	100	Z12	Sl. / Fig. 20
69	?	?	1,6	100	Z13	
70	?	?	1,7	100	Z14	
71	?	?	1,7	100	Z15	
72	?	?	1,8	100	Z16	

### Zahvale

Raziskavo ladje, ki jo je vodil Center za konservatorstvo ZVKDS, sta omogočila Ministrstvo za izobraževanje, znanost, kulturo in šport ter Agencija RS za raziskovalno dejavnost (programa Lesarstvo P4-0015 in Računalniški vid P2-0214 in projektov J6-6348-0618, J6-4087 in L6-4157).

Pri raziskavah so sodelovali sodelavci Muzeja in galerij mesta Ljubljane, Univerze v Ljubljani (Laboratorij za računalniški vid Fakultete za računalništvo in informatiko ter Oddelek za lesarstvo, Oddelek za mikrobiologijo in Katedra za botaniko in fiziologijo rastlin Oddelka za biologijo Biotehniške fakultete), Inštitut za arheologijo ZRC SAZU, Rok Kovačič (Golden Light Photography Kult, d. o. o.), Gregor Berginc (Xlab, d. o. o., in 3dimenzija, d. o. o.), Predrag Petrović in Luka Ritonja (ArtRebel9, d. o. o.), Tomaž Verbič (Arhej, d. o. o.), Sašo Poglajen (Harpha Sea, d. o. o.) in potapljači CPA, d. o. o.

Na terenu so strokovno pomoč in podporo zagotovili Luka Bekić, Anita Jelić (Međunarodni centar za podvodnu

arheologiju u Zadru) ter Marko Uhač (Uprava za zaščito kulturne baštine Ministarstva kulture Republike Hrvatske), s komentarji in pogovori pa Ronald Bockius (Museum für Antike Schifffahrt, Römisch-Germanisches Zentralmuseum, Mainz), Giulia Boetto (Centre Camille Jullian, Chargée de recherche au CNRS, Aix-en-Provence) ter Jana Horvat (ZRC SAZU, Inštitut za arheologijo).

Tehnično pomoč pri slikovnem gradivu so zagotovile Ida Murgelj (Narodni muzej Slovenije), Janja Tratnik (Inštitut za dediščino Sredozemlja ZRS Univerze na Primorskem) in Mateja Belak (ZRC SAZU, Inštitut za arheologijo).

Iskreno zahvalo za donatorsko podporo pa smo dolžni predvsem Magelan Skupini, d. o. o., Občini Vrhnika, Komunalnemu podjetju Vrhnika, d. o. o., Avtotradu, d. o. o., Gostilni Bajc s prenočišči, Realprojektu, d. o. o., Prostovoljnemu gasilskemu društvu Bevke, Kamnolomu Mivšek – Rajko Mivšek s. p., Planinskemu društvu Vrhnika, Cankarjevi knjižnici Vrhnika ter Ribiški družini Vrhnika.

ANDERSON, B. D. 2003, *The Physics of Sailing Explained*. – Dobbs Ferry (NY).

ARNOLD, B. 1992, *Batellerie gallo-romaine sur le lac de Neuchâtel 2*. – Archéologie neuchâteloise 13.

BELTRAME, C. 2000, Sutiles naves of Roman Age. New Evidence and Technological Comparisons with Preroman Sewn Boats. – V / In: J. Litwin (ur. / ed.), *Down the River to the Sea. Proceedings of the Eighth International Symposium on Boat and Ship Archaeology*, 91–96, Gdansk, Oxford.

BELTRAME, C., D. GADDI 2013, Fragments of Boats from the Canale Anfora of Aquileia, Italy, and Comparison of Sewn-Plank Ships in the Roman Era. – *The International Journal of Nautical Archaeology* 42/2, 296–304.

BERTI, F. 1990, Lo scafo. – V / In: F. Berti (ur. / ed.), *Fortuna Maris. La Nave Romana di Comacchio*, 29–42, Bologna.

BJÖRDAL GJELSTRUP, C. 2012, Microbial degradation of waterlogged archaeological wood. – *Journal of Cultural Heritage* 13, 118–122.

BOCKIUS, R. 2000, Antike Prahme. Monumentale Zeugnisse keltisch-römischer Binnenschifffahrt aus der Zeit vom 2.

Jh. v. Chr. bis ins 3. Jh. n. Chr. – *Jahrbuch des Römisch-germanischen Zentralmuseums Mainz* 47, 439–493.

BOCKIUS, R. 2001, A Roman River Barge (?) found in the Danube near Prahovo, Serbia. – V / In: C. Beltrame (ur. / ed.), *Boats, Ships and Shipyards, Proceedings of the Ninth International Symposium on Boat and Ship Archaeology, Venice, 3.–8. December 2000*, 167–196, Oxford.

BOCKIUS, R. 2002a, Abdichten, beschichten, kalfatern. Schiffsversiegelung und ihre Bedeutung als Indikator für Technologietransfers zwischen den antiken Schiffbautraditionen. – *Jahrbuch des Römisch-germanischen Zentralmuseums Mainz* 49, 189–234.

BOCKIUS, R. 2002b, *Die römerzeitlichen Schiffsfunde von Oberstimm in Bayern*. – Monographien Römisch-germanisches Zentralmuseums 30.

BOCKIUS, R. 2011, Technological Transfer from the Mediterranean to the Northern Provinces. – V / In: G. Boetto, P. Pomey, A. Tchernia (ur. / eds.), *Batellerie Gallo-Romaine: pratiques régionales et influences maritimes Méditerranéennes*, Bibliothèque d'archéologie Méditerranéenne et Africaine 9, 47–59.

- BOE, G. de 1978, Roman boats from a small river harbour at Pommeroeul, Belgium. – V / In: J. du Plat Taylor, H. Cleere (ur. / eds.), *Roman shipping and trade: Britain and the Rhine provinces*, Council British Archaeological Research Report 24, 22–30.
- BOETTO, G., C. ROUSSE 2011, Le chaland de Lipe (Ljubljana, Slovénie) et la tradition de construction "sur sole" de l'Europe sud-orientale: quelles influences méditerranéennes? – V / In: G. Boetto, P. Pomey, A. Tchernia (ur. / eds.), *Batellerie Gallo-Romaine: pratiques régionales et influences maritimes Méditerranéennes*, Bibliothèque d'archéologie Méditerranéenne et Africaine 9, 179–191.
- BOETTO, G., C. ROUSSE 2012, Traditions régionales d'architecture navale en adriatique à l'époque romaine. – *Histria Antiqua* 21, 427–441.
- BRUSIĆ, Z., M. DOMJAN 1985, Liburnian boats: their construction and form. – V / In: S. McGrail, E. Kentley (ur. / eds.), *Sewn Plank Boats*, BAR International Series 276, 67–86.
- BRUNNING, R., J. WATSON 2010, *Waterlogged wood. Guidelines on the recording, sampling, conservation and curation of waterlogged wood*. – English Heritage 2010, Swindon (<http://www.english-heritage.org.uk/publications/waterlogged-wood/waterlogged-wood.pdf> [zadnji dostop / last access 30. april 2014]).
- CAPRETTI, C., N. MACCHIONI, B. PIZZO, G. GALOTTA, G. GIACHI, D. GIAMPAOLA 2008, The characterization of waterlogged archaeological wood: The three roman ships found in Naples (Italy). – *Archaeometry* 50, 855–876.
- CHRISTENSEN, M., H. KUTZKE, F. K. HANSEN 2012, New materials used for the consolidation of archaeological wood – past attempts, present struggles, and future requirements. – *Journal of Cultural Heritage* 13, 183–190.
- ČUFAR, K. 2010, Dendrokronološka metoda za datiranje lesa v Sloveniji. – *Argo* 53/1, 30–33.
- ČUFAR, K., M. MERELA, M. ERIČ 2014, A Roman barge in the Ljubljana river (Slovenia): wood identification, dendrochronological dating and wood preservation research. – *Journal of Archaeological Science* 44/April 2014, 128–135.
- ČUFAR, K., V. TIŠLER, GORIŠEK, Ž. 2002, Arheološki les - njegove lastnosti in raziskovalni potencial (Archaeological wood - its properties and research potential). – *Arheološki vestnik* 53, 69–76.
- ČUFAR, K., Ž. GORIŠEK, M. MERELA, F. POHLEVEN 2012, Lastnosti bukovega lesa, predelava, problematika in raba v arhitekturi. – V / In: A. Bončina (ur. / ed.), *Bukovi gozdovi v Sloveniji: ekologija in gospodarjenje*, Zbornik razširjenih povzetkov predavanj, 26. gozdarski študijski dnevi, Čatež ob Savi, 2. in 3. april 2008, 445–458, Ljubljana.
- ČUFAR, K., J. GRIČAR, M. ZUPANČIČ, G. KOCH, U. SCHMITT 2008, Anatomy, cell wall structure and topochemistry of water-logged archaeological wood aged 5,200 and 4,500 years. – *IAWA Journal* 29, 55–68.
- DEŽMAN, K. 1858, Beiträge zur Naturgeschichte des Laibacher Morastes. – *Jahresheft des Vereines des krainischen Landesmuseums* 2, 59–87.
- DEŽMAN, K. 1878, Über die vorjährigen Funde im Laibacher Pfahlbau. – *Mitteilungen der Anthropologischen Gesellschaft in Wien* 8, 65–82.
- DJAOUI, D., S. GRECK, S. MARLIER 2012, *Arles-Rhône 3. Le naufrage d'un chaland antique dans le Rhône, enquête pluridisciplinaire*. – Marseille.
- DRAP, P., D. MERAD, J. SEINTURIER, A. MAHIDDINE, D. PELOSO, JM. BOÏ, L. LONG, B. CHEMISKY, J. GARRABOU 2013, Underwater photogrammetry for archaeology and marine biology 40 years of experience in Marseille, France. – V / In: A. C. Addison, G. Guidi, L. De Luca, S. Pescarin (ur. / eds.), *Proceedings of the 2013 Digital Heritage International Congress 2013, 28 Oct - 1 Nov, Marseille, France*, IEEE 2, 97–104, Marseille.
- ERIČ, M. 1994, Nova datiranja deblakov in čolnov. – *Arheo* 16, 74–78.
- ERIČ, M. 1998, *Moker les iz arheoloških najdišč v Sloveniji*. – Magistrska naloga / Master's thesis, Oddelek za arheologijo, Filozofska fakulteta Univerze v Ljubljani.
- ERIČ, M. 2008, *Arheologija Ljubljanskega barja. Ladje, deblaki, čolnici in vesla*. – Poročila skupine za podvodno arheologijo 26, [Poročila 26, Zavod za varstvo kulturne dediščine Slovenije]. Poročilo / Report (<https://uni-aas.academia.edu/MiranErič/OVER-100-READS> [zadnji dostop / last access 30. april 2014]).
- ERIČ, M. 2009a, Datirani deblaki in ladja na Ljubljanskem barju in v Prekmurju v Sloveniji. – V / In: L. Bekić (ur. / ed.), *Jurišičev zbornik. Zbornik radova u znak sjećanja na Marija Jurišića*, 151–162, Zagreb.
- ERIČ, M. 2009b, *Rimska tovorna ladja SI-80: poročilo o nadzoru stanja ladje po posegih ob Sinjegoriških ribnikih*. – Poročila oddelka za podvodno arheologijo 1, [Poročila 1, Zavod za varstvo kulturne dediščine Slovenije, Center za preventivno arheologijo]. Poročilo / Report (<https://uni-aas.academia.edu/MiranErič/REPORTS> [zadnji dostop / last access 30. april 2014]).
- ERIČ, M., A. GASPARI 2009, *Sinja Gorica: poročilo o arheološkem podvodnem pregledu struge reke Ljubljane na območju zavarovanja desne brežine ob Sinjegoriških ribnikih*. – Poročila skupine za podvodno arheologijo 28, [Poročila 28, Zavod za varstvo kulturne dediščine Slovenije]. Poročilo / Report (<https://uni-aas.academia.edu/MiranErič/REPORTS> [zadnji dostop / last access 30. april 2014]).
- ERIČ, M., I. ŠINKOVEC 2013, *Rimska tovorna ladja iz Sinje Gorice 1: dokumentiranje ladje in vzpostavitev državnega depozitorija za moker les 2012*. – Poročila skupine za podvodno arheologijo 30, [Poročila 30, Zavod za varstvo kulturne dediščine Slovenije]. Poročilo / Report (<https://uni-aas.academia.edu/MiranErič/REPORTS> [zadnji dostop / last access 30. april 2014]).
- ERIČ, M., R. KOVAČIČ, G. BERGINC, M. PUGELJ, Ž. TOPINJŠEK, F. SOLINA 2013, The Impact of the Latest 3D Technologies on the Documentation of Underwater Heritage Sites. – V / In: A. C. Addison, G. Guidi, L. De Luca, S. Pescarin (ur. / eds.), *Proceedings of the 2013 Digital Heritage International Congress 2013, 28 Oct - 1 Nov, Marseille, France*, IEEE 2, 281–288, Marseille.
- FOZZATTI, L., M. CAPULLI, F. CASTRO 2012, The Stella 1 Shipwreck, Udine, Italy. – *Center for Maritime Archaeology & Conservation News and Reports* 3/2, 17–19.
- GASPARI, A. 1998a, Pontonium iz Lip na Ljubljanskem barju. – *Arheološki vestnik* 49, 187–224.

- GASPARI, A. 1998b, Das Frachtschiff aus Lipe in Moor von Laibach (Ljubljana). – *Jahrbuch des Römisch-germanischen Zentralmuseums Mainz* 45, 527–550.
- GASPARI, A. 2002, *Latenske in zgodnjerske najdbe iz Ljubljane*. – Doktorska disertacija / Dissertation. Oddelek za arheologijo, Filozofska fakulteta Univerze v Ljubljani.
- GASPARI, A. 2009a, Tovorna ladja sredozemske šivane konstrukcije iz Lip. – V: P. Turk, J. Istenič, T. Knific, T. Nabergoj (ur. / eds.), *Ljubljana – kulturna dediščina reke*, 107–109, Ljubljana.
- GASPARI, A. 2009b, A cargo ship of Mediterranean sewn construction from Lipe. – In: P. Turk, J. Istenič, T. Knific, T. Nabergoj (ur. / eds.), *The Ljubljana – a River and its Past*, 116–119, Ljubljana.
- GASPARI, A., M. ERIČ 2002, *Podvodno dokumentiranje lesenih plovil v strugi Ljubljane na Ljubljanskem barju*. – Poročilo / Report. Hrani / Kept in: Oddelek za kulturo in raziskovalno dejavnost Mestne občine Ljubljana.
- GASPARI, A., M. ERIČ 2006–2007, 229. Vrhnika. Arheološko najdišče Ljubljana. – *Varstvo spomenikov* 43 (2007). *Poročila*, 237–240.
- GASPARI, A., M. ERIČ 2007, *Arheološki podvodni pregled struge reke Ljubljane na območju mostu AC priključka na Vrhniko*. – Poročila skupine za podvodno arheologijo 23, [Poročila 23, Zavod za varstvo kulturne dediščine Slovenije]. Poročilo / Report (<https://uni-aas.academia.edu/MiranErič/REPORTS> [zadnji dostop / last access 30. april 2014]).
- GASPARI, A., M. ERIČ 2008, Arheološke raziskave struge Ljubljane med Verdom in Vrhniko. – *Annales. Series historia et sociologia*, 18/2, 407–430.
- GASPARI, A., M. ERIČ 2012, Preliminarno poročilo o odkritju razbitine rimske tovorne ladje v Ljubljani pri Sinji Gorici. – V / In: A. Gaspari, M. Erič (ur. / eds.), *Potopljena preteklost. Arheologija vodnih okolij in raziskovanje podvodne kulturne dediščine v Sloveniji. Zbornik ob 128-letnici Dežmanovih raziskav Ljubljane na Vrhniko (1884–2012)*, 293–298, Radovljica.
- GASPARI, A., M. ERIČ, B. ODAR 2011, A Palaeolithic wooden point from Ljubljansko barje, Slovenia. – V / In: J. Benjamin, C. Bonsall, C. Pickard, A. Fischer (ur. / eds.), *Submerged prehistory*, 186–192, Oxford, Oakville.
- GASPARI, A., M. ERIČ, B. ODAR 2012, Paleolitska lesena konica iz Ljubljane. – V / In: A. Gaspari, M. Erič (ur. / eds.), *Potopljena preteklost. Arheologija vodnih okolij in raziskovanje podvodne kulturne dediščine v Sloveniji. Zbornik ob 128-letnici Dežmanovih raziskav Ljubljane na Vrhniko (1884–2012)*, 231–238, Radovljica.
- GASPARI, A., M. ERIČ, M. ŠMALCELJ 2006, Roman river barge from Sisak (*Siscia*), Croatia. – V / In: L. Blue, F. Hocker, A. Englert (ur. / eds.), *Connected by the Sea, Proceedings of the Tenth International Symposium on Boat and Ship Archaeology, Roskilde, 22–27 September 2003*, 284–289, Oxford.
- GLUŠČEVIČ, S. 2004, Hydroarchaeological excavations and the discovery of the third sewn Liburnian ship - serilliae - in the Roman harbor of Zaton near Zadar. – *Archaeologia Maritima Mediterranea. An International Journal on Underwater Archaeology* 1, 41–52.
- GREGORY, D., P. JENSEN, K. STRÆTKVERN 2012, Conservation and in situ preservation of wooden shipwrecks from marine environments. – *Journal of Cultural Heritage* 13, 139–148.
- GROSSER, D., W. TEETZ 1987, *Einheimische Nutzhölzer, Loseblattsammlung: Vorkommen, Baum- und Stammform, Holzbeschreibung, Eigenschaften, Verwendung*. – Bonn.
- GUYON, M., É. RIETH 2011, Les chalands gallo-romains du Parc Saint-Georges. – V / In: G. Boetto, P. Pomey, A. Tchernia (ur. / eds.), *Batellerie Gallo-Romaine: pratiques régionales et influences maritimes Méditerranéennes*, Bibliothèque d'archéologie Méditerranéenne et Africaine 9, 91–101.
- HANEGA, K., K. ČUFAR, H. BEECKMAN 2009, Oaks, tree-rings and wooden cultural heritage: a review of the main characteristic and applications of oak dendrochronology in Europe. – *Journal of Archaeological Science* 36, 1–11.
- HOCKER, E., G. ALMKVIST, M. SAHLSTEDT 2012, The Vasa experience with polyethylene glycol: A conservator's perspective. – *Journal of Cultural Heritage* 13, S175–S182.
- HOLK van, A. 2011, Recent research on Roman shipfinds from the Netherlands. – V / In: G. Boetto, P. Pomey, A. Tchernia (ur. / eds.), *Batellerie Gallo-Romaine: pratiques régionales et influences maritimes Méditerranéennes*, Bibliothèque d'archéologie Méditerranéenne et Africaine 9, 33–43.
- HOHENWART, F. 1838, *Die Entsumpfung des Laibacher Morastes*. – Besonders adgedrückt aus dem 3. u. 4. Hefte der Beiträge für Naturgeschichte, Landwirtschaft und Topographie des Herzogtums Krain, Laibach.
- HORVAT, J. 1990, *Nauportus (Vrhniko)*. – Dela 1. razreda SAZU 33.
- HORVAT, J. 1996, Nauportus – Vrhniko v arheoloških obdobjih. – *Vrhniški razgledi* 1, 89–106.
- HORVAT, J. 2009a, Nauportus – naselje na začetku transportne poti po Ljubljani. – V: P. Turk, J. Istenič, T. Knific, T. Nabergoj (ur. / eds.), *Ljubljana: kulturna dediščina reke*, 89–94, Ljubljana.
- HORVAT, J. 2009b, Nauportus – a settlement at the beginning of the transportation route along the Ljubljana. – In: P. Turk, J. Istenič, T. Knific, T. Nabergoj (ur. / eds.), *The Ljubljana – a River and its Past*, 96–101, Ljubljana.
- HORVAT, J., E. KOCUVAN, N. LOGAR 1986, Vrhniko - Dolge njive. – *Varstvo spomenikov* 28, 277–278.
- HUMAR, M., B. FABČIČ, M. ZUPANČIČ, F. POHLEVEN, P. OVEN 2008, Influence of xylem growth ring width and wood density on durability of oak heartwood. – *International Biodeterioration and Biodegradation* 62, 368–371.
- KONCANI UHAČ, I., M. UHAČ 2012, Prapovijesni brod iz uvale Zambratija – prva kampanja istraživanja. – *Histria Antiqua* 21, 533–538.
- LEHMANN, L. Th. 1990, The Romano-Celtic boats from Druuten and Kapel-Avezaath. – V / In: S. McGrail (ur. / ed.), *Maritime Celts, Frisians and Saxons*, Council British Archaeological Research Report 71, 77–81.
- LESAR, B., M. HUMAR, P. OVEN 2008, Dejavniki naravne odpornosti lesa in njegova trajnost / Factors of natural durability and service life of wood. – *Les* 60 (11/12), 408–414.

- LOGAR, N. 1984, Ljublanica na Ljubljanskem barju. – *Varstvo spomenikov* 26, 232–233.
- LOGAR, N. 1985, Vrhnika / Dolge njive. – *Arheološki pregled* 26 (1986), 126–127.
- MARLIER, S. 2002, La question de la survivance des bateaux cousus de l'Adriatique. – V / In: L. Rivet, M. Sciallano (ur. / eds.), *Vivre, produire et échanger: Reflets Méditerranéens. Mélanges offerts à Bernard Lou*, Archéologie et Histoire Romaine 8, 21–32.
- MARLIER, S. 2011, L'épave Arles-Rhône 3: étude préliminaire d'un chaland gallo-romain. – V / In: G. Boetto, P. Pomey, A. Tcherna (ur. / eds.), *Batellerie Gallo-Romaine: pratiques régionales et influences maritimes Méditerranéennes*, Bibliothèque d'archéologie Méditerranéenne et Africaine 9, 133–151.
- MCGRAIL, S. 2001, *Boats of the world: from the Stone Age to the Medieval times*. – New York.
- MELIK, A. 1946, *Ljubljansko mostiščarsko jezero in dediščina po njem*. – Dela 1. razreda SAZU 5.
- MERELA, M., K. ČUFAR 2013, Mechanical properties of oak sapwood versus heartwood in three different oak species / Gustoća i mehanička svojstva drva bjeljike hrasta u usporedbi s drvom srži. – *Drvna Industrija* 64/4, 323–334.
- MUŠIČ, B., J. HORVAT 2007, Nauportus - an Early Roman trading post at Dolge njive in Vrhnika. The results of geophysical prospecting using a variety of independent methods / *Nauportus - zgodnjerimska trgovska postojanka na Dolgih njivah na Vrhniki*. Rezultati geofizikalne raziskave z več neodvisnimi metodami. – *Arheološki vestnik* 58, 219–283.
- MÜLLNER, A. 1890a, Ein Schiff im Laibacher Moore I. – *Laibacher Zeitung* 266, 19. 11. 1890, 2217–2218.
- MÜLLNER, A. 1890b, Ein Schiff im Laibacher Moore II. – *Laibacher Zeitung* 267, 20. 11. 1890, 2225–2226.
- MÜLLNER, A. 1892a, Einbäumler im Moraste. – *Argo* 1/1, 18.
- MÜLLNER, A. 1892b, Ein Schiff im Laibacher Moore. – *Argo* 1/1, 1–7.
- MÜLLNER, A. 1894, Kleinere Mittheilungen. – *Argo* 3, 153–157.
- MÜLLNER, A. 1897, Fund eines Einbaumes am Moore bei Schwarzdorf. – *Argo* 5, 85–86.
- POLZER, M. E. 2009, The Vith-Century B.C. Shipwreck at Pabuç Burnu, Turkey: Evidence for Transition from Lacing to Mortise-and-Tenon Joinery in Late Archaic Greek Shipbuilding. – V / In: P. Pomey (ur. / ed.), *Transferts technologiques en architecture navale méditerranéenne de l'antiquité aux temps modernes: identité technique et identité culturelle, Actes de la Table Ronde d'Istanbul, 19–22 mai 2007*, *Varia Anatolica* 20, 27–44.
- POMEY, P. 1997, Un exemple d'évolution des techniques de construction navale antique: de l'assemblage par ligatures à l'assemblage par tenons et mortaises. – V / In: D. Meeks, D. Garcia (ur. / eds.), *Techniques et économie antiques et médiévales: le temps de l'innovation*. Colloque international (C. N. R. S.) Aix-en-Provence 21–23 Mai 1996, 195–203, Paris.
- RADIĆ ROSSI, I., G. BOETTO 2011, Šivani brod iz uvale Caska na Pagu – istraživačka kampanja 2010. – *Histria Antiqua* 20, 505–513.
- RIVAL, M. 1991, *La charpenterie navale romaine: matériaux, méthodes, moyens*. – Travaux du Centre Camille Jullian 4, Paris.
- REIMER, P. J. et al. 2009, IntCal09 and Marine09 radiocarbon age calibration curves, 0–50,000 years cal BP. – *Radiocarbon* 51/4, 1111–1150.
- SALEMKE, G. 1973, Die Ausgrabung eines Binnensee-Transportschiffes. Schiffsarchaeologie von 1890 aus Laibach, Österreich (Jetzt Ljubljana in Jugoslawien). – *Das Logbuch* 9/1, 21–24.
- SCHOCH, W., I. HELLER, F. H. SCHWEINGRUBER, F. KIENAST 2004, *Wood anatomy of central European Species* (<http://www.woodanatomy.ch> [zadnji dostop / last access: 30. april 2014]).
- SCHWEINGRUBER, F. H. 1990, *Microscopic wood anatomy / Mikroskopische Holz Anatomie, Eidgenössische Anstalt für das Forstliche Versuchswesen*. – Birmensdorf.
- SINGH, A. P. 2012, A review of microbial decay types found in wooden objects of cultural heritage recovered from buried and waterlogged environments. – *Journal of Cultural Heritage* 13, 16–20.
- STOPINŠEK, Ž., G. BERGINC, M. ERIČ, F. SOLINA 2013, Uvajanje 3D tehnologij pri varstvu kulturne dediščine. – V / In: B. Potočnik (ur. / ed.), *ROSUS 2013: računalniška obdelava slik in njena uporaba v Sloveniji 2013*. Zbornik 8. strokovne konference, Maribor, 21. marec 2013. FERI, Univerza v Mariboru (<http://cobsis.uni-mb.si/rosus2013/ROSUS2013-splet.pdf> [zadnji dostop / last access: 30. april 2014]).
- TIBONI, F. 2009, Chioggia. Località di Motta di Cavanella d'Adige. Le operazioni di scavo e primo studio di un relitto del II-I secolo a.C. – *Quaderni di Archeologia del Veneto* 25, 82–83.
- VELUŠČEK, A., K. ČUFAR, M. ZUPANČIČ 2009, Prazgodovinsko leseno kolo z osjo s kolišča Stare gmajne na Ljubljanskem barju / Prehistoric wooden wheel with an axle from the pile-dwelling Stare gmajne at the Ljubljansko barje. – V / In: A. Velušček (ur. / ed.), *Koliščarska naselbina Stare gmajne in njen čas. Ljubljansko barje v 2. polovici 4. tisočletja pr. Kr. / Stare gmajne pile-dwelling settlement and its era. The Ljubljansko barje in the 2nd half of the 4th millennium BC*, Opera Instituti Archaeologici Sloveniae 16, 197–222.
- VELUŠČEK, A., D. VERANIČ, K. ČUFAR, 2009, Drevaka s koliščarske naselbine Stare gmajne na Ljubljanskem barju / Logboats from the pile-dwelling settlement Stare gmajne at the Ljubljansko barje. – V / In: A. Velušček (ur. / ed.), *Koliščarska naselbina Stare gmajne in njen čas. Ljubljansko barje v 2. polovici 4. tisočletja pr. Kr. / Stare gmajne pile-dwelling settlement and its era. The Ljubljansko barje in the 2nd half of the 4th millennium BC*, Opera Instituti Archaeologici Sloveniae 16, 223–234.
- VITRI, S. et al. 2003, Il relitto romano del fiume Stella (UD). – V / In: F. Lenzi (ur. / ed.), *L'Archeologia dell'Adriatico dalla Preistoria al Medioevo. Atti del convegno internazionale, Ravenna, 7–9 giugno 2001*, 324–338, Firenze.
- ZALOKAR, J. 1854, *Umno kmetovanje in gospodarstvo*. – Ljubljana.

# Early Roman barge from the Ljubljanica River at Sinja Gorica

## Translation

1. Introduction ( <i>Miran ERIČ</i> ) .....	232
Fieldwork in 2008 .....	232
Circumstances of find .....	233
Fieldwork in 2009 and 2012 .....	234
2. Stratigraphic position ( <i>Tomaž VERBIČ, Miran ERIČ</i> ) .....	234
3. Documentation ( <i>Franc SOLINA, Miran ERIČ</i> ) .....	235
4. Dating, wood identification and wood condition assessment ( <i>Katarina ČUFAR, Miran ERIČ</i> ) .....	236
Radiometric dating .....	236
Wood identification and dendrochronological dating .....	236
Wood condition assessment .....	238
5. Barge construction ( <i>Miran ERIČ</i> ) .....	238
Construction elements .....	238
Caulking and joining .....	240
Wood working, traces of use and other .....	240
6. Construction sequence and shape ( <i>Miran ERIČ</i> ) .....	241
Construction sequence .....	241
Shape .....	241
7. Comparative analysis of the barge's constructional and technological characteristics and its place in the regional shipbuilding practice ( <i>Andrej GASPARI</i> ) .....	242
8. Conclusion .....	248
9. Catalogue ( <i>Miran ERIČ</i> ) .....	249
Bibliography .....	228

## 1. INTRODUCTION

### Fieldwork in 2008

In advance of maintenance work, more precisely the right bank consolidation of the Ljubljanica River, the Underwater Archaeology Division (hereinafter SPA) of the Institute for the Protection of Cultural Heritage of Slovenia (hereinafter ZVKDS) surveyed a 200m long section of the river at Sinja Gorica (*Fig. 1: c*).<sup>1</sup> The intensive underwater survey of the potentially endangered riverbed (Heritage Register Number 11420) along plots Nos. 1100,

1125, and 1865/1, cadastral municipality Verd, was performed under the auspices of the ZVKDS.<sup>2</sup>

The survey of 44 square grids revealed 2500 small finds, mostly fragments of prehistoric, Roman, medieval, early modern, as well as modern pottery and construction materials. Noteworthy finds include an Early Roman Aucissa fibula, an undated iron ingot weighing roughly 10kg and a wooden Palaeolithic point, presumably part of a

<sup>1</sup> Erič, Gaspari 2009a; Erič et al. 2009.

<sup>2</sup> The survey team consisted of Miran Erič, ZVKDS SPA, Rok Kovačič, Marko Gasparič and Oskar Musić, divers of DRM Ljubljana, Gašper Košir, Anže Košir, Marjan Vidmar, Zlatko Kovač and Matej Draksler, divers of the Trident sports club, and Marko Gaspari, geodetic technician.

45,000-year-old hunting weapon.<sup>3</sup> In the easternmost part of the surveyed area, along Grid Squares 35 and 36, the survey also revealed the remains of a wooden barge (*Fig. 1: d; 2*).<sup>4</sup> Its remains, consisting of the left and right chine-girders, five planks of the flat bottom and iron clamps, are lying horizontally and continue at an angle into the sediments of the river bank. Probably also belonging to the vessel are the 15 iron clamps and two wrought nails found scattered in close vicinity (*Pl. 1*). The survey determined the approximate width between the chine-girders at 2.4m, which, together with the obtained radiocarbon age, pointed to a 12 to 15m long barge from the closing decades BC or the early decades AD.

### Circumstances of find

This important find of a barge in the Ljubljana near Sinja Gorica (hereinafter barge from Sinja Gorica) is not a complete surprise, for two reasons. The first is the natural conditions in the moors of the Ljubljansko barje and in the Ljubljana, which are very favourable for preserving wooden finds. The hydrogeological and geomorphological conditions in the Ljubljansko barje and in particular the high groundwater level are favourable for the preservation of all organic materials. A multitude of logboats and other vessels thus came to be preserved. We know of 76<sup>5</sup> vessels thus far, which include the two earliest dendrochronologically dated logboats (3211 and 3136 BC) from the Stare gmajne pile-dwelling site,<sup>6</sup> but also several logboats dated to the 1<sup>st</sup> century BC and 1<sup>st</sup> century AD.<sup>7</sup>

<sup>3</sup> Gaspari, Erič, Odar 2011; 2012.

<sup>4</sup> At a depth of 2.5m under mean water surface, at an absolute altitude of 284.11m and GK coordinates of y 446827, x 92200.

<sup>5</sup> More on logboats and other types of vessels in Hohenwarth 1838, 79, 87, 89; Dežman 1858; id. 1878; Müllner 1892a; id. 1894; id. 1897; Melik 1946, 71, note 121; Curk et al. 1981; Mali, Vuga 1978; Erič 1994; id. 1998; id. 2008; id. 2009a; and in an unpublished report by I. Curk et al. (I. Curk, I. Nemeč, B. Vičič, D. Vuga, *Elaborat - Analiza konservatorskega problema v zvezi z lesom in drugimi organskimi ostalinami v arheoloških najdiščih*, Zavod SR Slovenije za varstvo naravne in kulturne dediščine [Ljubljana 1981]).

<sup>6</sup> Velušček, Veranič, Čufar 2009.

<sup>7</sup> Erič 2008; the Vrhnik I (SI-60)/1<sup>st</sup> c. AD, Jelovšek (SI-02)/1<sup>st</sup> c. BC, Krtina I (SI-04)/1<sup>st</sup> c. BC, Krtina II (SI-05)/2<sup>nd</sup> c. AD and Žitnik logboats (SI-06)/1<sup>st</sup> c. AD.

As early as October 1890, an important find came to light in the area of Brezov log at Lipe, on the estate of Josip Kozler. Digging a drainage channel revealed a 30m long and 4.8m wide barge (hereinafter barge from Lipe), which is considered one of the best preserved vessels of the Roman period. Alfons Müllner, curator in the provincial museum in Ljubljana, documented the barge and concluded that it was pre-Roman in date on the basis of stratigraphy.<sup>8</sup> Much later, radiometric dates attributed the barge to the second half of 1<sup>st</sup> century BC or the very beginning of the 1<sup>st</sup> century AD.<sup>9</sup> Because of its construction characteristics, the barge is still frequently discussed by the researchers of Roman shipbuilding.

The second reason for the find from Sinja Gorica not being such a surprise is its location – it came to light only 300m east of the Early Roman settlement of *Nauportus* with warehouses, a harbour and defence walls with a ditch, situated in the bend of the Ljubljana at Dolge njive (*Fig. 1: a*).<sup>10</sup> The small finds show that this settlement was abandoned in the first half of the 1<sup>st</sup> century AD and the transportation activities and life relocated to Breg (*Fig. 1: b*), on the opposite bank of the river and along the main road (*via publica*) between *Aquileia* and *Emona*. The numerous small finds in the riverbed along the settlement, as well as downstream reveal the importance of this area for the military.<sup>11</sup>

The riverbed of the Ljubljana at Sinja Gorica, where the barge was found, is 25m wide and 2.5–4m deep at mean water level. It is partially cut into river alluvia and Late Pleistocene and Early Holocene lacustrine sediments. The bottom of the riverbed is mostly covered by extensive deposits of sand and silt (*Fig. 4: A,B*). The river bank between the ponds at Sinja Gorica and the Ljubljana is unstable and had to be reinforced several times during the 20<sup>th</sup> century, by wooden piles driven into the bank and the space behind them filled with rough stones. This reinforcement was gradually deteriorating in recent decades.

<sup>8</sup> Müllner 1890a; id. 1890b; id. 1892b.

<sup>9</sup> More on barge and circumstances Gaspari 1998a; id. 1998b; id. 2009a.

<sup>10</sup> For more on the investigation, circumstances and geostrategic position of the settlement see Logar 1984; ead. 1986; Horvat, Kocuvan, Logar 1986; Horvat 1990; ead. 1996; ead. 2009; Gaspari 2002; Mušič, Horvat 2007.

<sup>11</sup> More about finds Horvat 1990; ead. 1996; ead. 2009; Mušič, Horvat 2007; Gaspari, Erič 2002; id. 2007a; id. 2007b; id. 2008.

## Fieldwork in 2009 and 2012

In May of 2009, the ZVKDS SPA conducted non-invasive documentation of the barge also aimed at establishing the state of its wooden remains eight months after discovery.<sup>12</sup> These were found to be exposed to water flow erosion due to the maintenance of the right river bank and therefore exceedingly endangered.

On the initiative of the ZVKDS, the Slovenian Ministry of Education, Science, Culture and Sports/*Ministrstvo za šolstvo, znanost, kulturo in šport* provided, in October 2012, intervention funds for documenting the barge and transferring it to the state depository for waterlogged wood in preparation in the nearby ponds. The task of the ZVKDS SPA research team was thus to document the remains of the vessel and to transfer them to the depository. The team was made up of several groups of collaborators and advisers, while a considerable contribution to the fieldwork was also provided by donations by the local community.<sup>13</sup>

It took eleven members of the field team and several assistants 150 diving hours in 23 days to document the wreck and 36 hours to prepare the wooden support construction of the depository. The barge without cargo or objects identifiable as boat equipment was cleaned of recent sediments in the length of 4.2m (*Fig. 3*). On the eastern side of the barge, the side plank could be followed for another 3m, but was not documented due to safety concerns (*see Figs. 4; 10*).

The surviving part of the barge was substantially larger than expected, which caused the initial plan to transfer the barge to the depository for waterlogged wood to be abandoned. We rather opted for protection *in situ*; the cleared part of the barge was documented and afterwards protected with a thin layer of silt and sand, which was covered first with a degradable anti-flood net made of jute and then with sandbags.

*Erič*

## 2. STRATIGRAPHIC POSITION

The wreck rests in the part of the Ljubljanica downstream from Dolge njive where the river has

<sup>12</sup> Erič 2009b; documentation was performed by Miran Erič and Rok Kovačič, the latter Golden Light Photography.

<sup>13</sup> Erič, Sinkovec 2013.

an eastward course (*Fig. 1*). The uncovered remains of the barge continue into the sediments of the right bank under a 46° angle and in the direction of approximately 292° to 112° (WNW–ESE), at an altitude between 283.90 and 284.60m (*Fig. 4*). To clarify the stratigraphic position of the remains of the barge, three samples<sup>14</sup> of the sedimentary profile around the barge were taken from the profile at altitudes from 283.80 to 284.70m. Iron U-shaped profile, 0.5m long, was used for sediment sampling.

Samples 41 and 42 were extracted vertically and Sample 40 horizontally (*Fig. 4B*). They were examined macroscopically using a field magnifier and tested with reagents.<sup>15</sup> The analysis established four stratigraphic units:

- Layer 4 was established in the lower part, under the barge where the sample was taken, and consisted of very fine-grained greasy clay without a sand fraction, probably with only a small fraction of silt and without calcium carbonate (Samples 40 and 41; *Fig. 4: Layer 4; Fig. 5: Layer 4*). This distinguishes it from the typical lacustrine sediment of the Ljubljansko barje, i.e. the lacustrine chalk, and we can conclude that it is exclusively terrigenous material accumulating in the then existing lake.

- the up to 7cm thick “transition” Layer 3 (*Fig. 5: Layer 3*), lying between clay (Layer 4) and sand (Layer 2), was most probably formed by gravitational load at the contact between two different sediments. Because of liquefaction, sand was being pushed into the clay; we could observe small lenses of sand in the clay that represent static load structures. However, the observed structures could at least in part be the consequence of bioturbation, i.e. past activities of invertebrates.

- Layer 2 was a 26cm thick alluvial sandy sediment, discordantly deposited onto the clay of Layer 4 with a stratigraphic hiatus. Individual small clay inclusions in the fine- to medium-grained sand were probably rip-up-clasts moved by running water (*Fig. 5: Layer 2*).

- the top Layer 1 was roughly 80cm thick (Samples 41 and 42; *Fig. 5: Layer 1*) and consisted of

<sup>14</sup> Samples 40 (GK y 446821.849, x 92201.424), 41 (GK y 446820.239, x 92199.93) and 42 (GK y 446823.6056, x 92199.099). The coordinates mark the lower edge of the sampled spot (*Fig. 4*).

<sup>15</sup> The description of the layers is taken after: unpublished Report [On the analysis of sediment samples taken at the Roman cargo ship in Vrhnika (October 2012)] by Tomaž Verbič, Arhej d. o. o., who conducted the testing and analysis free of charge.



medium- to coarse-grained sand without any visible sedimentary structures and with a multitude of wood fragments. The sand was formed in an alluvial sedimentary environment, i.e. as an alluvium. The lithological diversity of sand grains indicates its origin in the valley of the Podlipščica.

The barge was not completely uncovered along its surviving side because of a poor condition of the wood. The sediment that covered the barge in the parts towards the river bank before cleaning (see *Fig. 10: Sediment 2*) corresponds with the description of layers above, while the sediment along the interior of the barge side (see *Fig. 10: Sediment 1*) included a large portion of wood fragments and branches, and also proved to be much more compact during uncovering and cleaning.

The documentation in 2009 also involved taking a sample of the clay sediment for OSL dating<sup>16</sup> in close vicinity of the barge (*Fig. 4: OSL*). The result showed the clay bottom, at an altitude 283.20m, to be  $17,000 \pm 1,600$  and  $9,000 \pm 1,300$  BP old.<sup>17</sup> The roughly 60cm of difference in altitude between the OSL sample and Sample 40 (*Fig. 4*) indicates a probable hydrogeological erosional deepening of the bottom of the riverbed during recent millennia.

The barge rests on the clay Layer 4 and is surrounded by layers of sandy alluvial backfillings (2–1) that most probably originate from the valley of the Podlipščica, possibly also from the valley of the Bela.

*Verbič, Erič*

### 3. DOCUMENTATION

Photogrammetry in underwater archaeology has a long history,<sup>18</sup> on the eastern coast of the Adriatic Sea as well.<sup>19</sup> Its beginnings had the same limitations as photogrammetry on dry land. It was a lengthy process of taking underwater photographs in a manner to assure as much alignment of photographs as possible, which was followed in the laboratory by the search for corresponding points in stereo pairs. This made underwater photogrammetric documentation more expensive than the manual or classic documentation, both

because of the extensive underwater work and of the painstaking laboratory processing.

Because of the limitations of time and money, the amount of photogrammetric measurements was, in the past, never sufficient for them alone to form the basis of field documentation and drawings of small finds and thus completely replace classic documentation. Modern computer-based photogrammetric methods, however, allow enough data to be captured to create a range or 3D image consisting of a dense point cloud where each point has all three coordinates. Groups of purposely taken images from different viewpoints allow the reconstruction of more or less complete 3D models. All the constraints regarding the accurate placement of cameras thus fall off. The camera can be held in the hand without any additional equipment, one must only capture a large enough set of photographs with a roughly 75% pairwise overlap. Computer software already exists that enables a 3D model reconstruction even from video images. An uncomplicated use in comparison with the classic methods of documentation is also a feature that makes this approach ever more frequently used in archaeological research.

Today, underwater photogrammetric collection of data is not only much more accurate and faster than classic documentation, but because of the shorter diving time necessary for taking photographs also faster, less expensive and safer. Of all the methods of underwater 3D documentation, photogrammetry has become the most useful.

To document the Roman barge from Sinja Gorica, we used a photogrammetric recording method to obtain a 3D model for the first time in Slovenia.<sup>20</sup> The photogrammetric reconstruction from a set of photographs is completely automatic and consists of the following stages: identification of discriminative points in individual photographs, search of stable correspondence among these points in different photographs, automatic calibration of a set of photographs, construction of a dense cloud of 3D points that best describes the information available on input photographs and finally creation of a triangulated textured network.

Such photogrammetrically derived 3D models (*Fig. 6*) have proven to be very accurate, representa-

<sup>16</sup> OSL = Optically Stimulated Luminescence; Gaspari, Erič, Odar. 2012, 236.

<sup>17</sup> Gaspari, Erič, Odar 2012, 236.

<sup>18</sup> Drap et al. 2013.

<sup>19</sup> Erič et al. 2013.

<sup>20</sup> Dedicated photography was done by Rok Kovačič (Golden Light Photography), 3D model was reconstructed by Gregor Berginc (Xlab Research, 3dimenzija) using his Mementify©PHOV photogrammetric software (<http://mementify.com>, <http://phov.eu>).

tive and usable for further analysis. For a manual documentation of the approx. 8m<sup>2</sup> large surface of the barge, at least 25 hours of diving time would be required, while it took only 3 hours to take dedicated photographs in four different stages of investigation. Sets of photographs were used to reconstruct three different 3D models. A comparison of two of them (Fig. 7), made in the *Laboratorij za računalniški vid* at the *Fakulteta za računalništvo in informatiko, Univerza v Ljubljani*, confirmed the accuracy of the documentation. The accuracy can be also confirmed indirectly, during the preparation of the graphic documentation from the obtained data. To verify the process of documentation, all measurements were also taken with a surveying instrument.

The potential of the data acquired in this way is not limited to visualizing 3D models. In contrast to 2D photographs, where the viewpoint is fixed, and the already interpreted 2D plans, a 3D model enables a simulated observation for study purposes from any virtual viewpoint and of any recorded surfaces and objects.<sup>21</sup> The morphological properties of 3D point clouds, which are a complete recording of the present state, open up countless options for further analyses of the 3D model. This is especially important because the investigation of an archaeological site is usually physically limited to the duration of the fieldwork and is later, if preserved *in situ*, difficult to access or most often destroyed. 3D models allow us to systematically and in a planned way study, segment and classify selected surfaces. Using automatic analysis of 3D surfaces, we can search for specific features that could otherwise easily be overlooked *in situ*. Also important is the archival sustainability of digital archaeological documentation, which forms the basis for later study, interpretation and promotion.

Solina, Erič

#### 4. DATING, WOOD IDENTIFICATION AND WOOD CONDITION ASSESSMENT

##### Radiometric dating

The documentation of the barge involved taking a wooden sample from the bottom plank (BP 2; Fig. 8: AMS) for radiometric dating. This was performed at the Beta Analytic Inc. in Miami using the AMS

<sup>14</sup>C<sup>22</sup> method and the result estimated the age at 2040 ± 40 BP (Beta - 249390). A second, repeated dating of the same sample was performed at the Radiocarbon Accelerator Unit at Oxford University and the result estimated the age at 2143 ± 26 BP (OxA - 19598). The results were calibrated with the Intcal 04 computer programme,<sup>23</sup> which gave the age of 50 BC–AD 20 (1σ) or 110 BC–AD 60 (2σ) (Beta) and 211–91 BC (1σ) or 206–157 BC (2σ) (OxA).

##### Wood identification and dendrochronological dating

The investigation conducted in 2012 included 17 samples taken for wood identification and basic wood analysis from the bottom planks, side planks, chine-girders, floor-timbers, side timbers and caulking (Fig. 8). To cause as little damage to the wooden parts as possible, the samples were small, usually only measuring a few cubic centimetres.

Wood identification process began by freezing the water-saturated wood samples. This was followed by cutting three 20μm thick transverse, radial and tangential slices from the samples. The slices were laid onto glass slides, immersed in glycerine and covered with a cover glass. They were analyzed under the Nikon Eclipse E800 microscope. Wood identification was performed using the identification keys for the wood of European coniferous and deciduous trees.<sup>24</sup>

The results showed that the sampled bottom planks (BP 1–BP 5), a side plank (SP 1) and two chine-girders (CG 1 and CG 2) were all made of beech wood (*Fagus sylvatica*), which represents the majority of the barge's wood volume (Fig. 8). Only smaller elements were made of other wood species; the floor-timbers of ash (*Fraxinus excelsior*) and elm (*Ulmus* sp.), and the side timbers of silver fir (*Abies alba*) and alder (*Alnus glutinosa*).

Only two of the 14 samples<sup>25</sup> were large enough for a dendrochronological analysis, namely Sample 23 from Bottom Plank 2 and Sample 34 from Side Plank 1 (Fig. 8). The wood was first frozen and the transverse surfaces of the wood smoothed with a scalpel. The tree-ring width was measured using

<sup>22</sup> Erič, Gaspari 2009; Gaspari, Erič 2012.

<sup>23</sup> Reimer et al. 2009.

<sup>24</sup> Schweingruber 1990; Schoch, Schweingruber, Kienast 2004.

<sup>25</sup> Samples 19, 26 and 28 were taken from the same construction elements.

<sup>21</sup> Erič et al. 2013; Stopinšek et al. 2013.

a LINTAB measurement table, Olympus stereo microscope and TSAP-Win software.

The bottom plank had 83 growth rings and the side plank only 40. The tree-ring series were visually synchronized to establish the date of the vessel and to cross-date it with the reference chronologies of the *Oddelek za lesarstvo* at the *Biotehniška fakulteta, Univerza v Ljubljani*.<sup>26</sup> Using several reference chronologies from the Roman times in Ljubljana (Tribuna site) and Vrhnika (Breg, Dolge njive), the dating was successful and determined the age of AD 3 of the outer growth ring. The best match for the dating was with the TRIFA904 beech chronology from the Ljubljana-Tribuna site, with the time interval from 176 BC to AD 2. The dating was confirmed with the following statistical parameters: t-value after Baillie-Pilcher TVBP = 6.0, coefficient of compliance (*Gleichläufigkeit*) GLK = 67\*\*\* and overlap OVL = 83 years. The values of the dating parameters are high and statistically significant, which can probably be explained by the TRIFA904 chronology being based on beech samples originating from forests in the vicinity of Vrhnika.

The growth ring with the date of AD 3 is located on the outer side of Bottom Plank 2. It does not, however, determine the exact year of the barge construction.<sup>27</sup> If the dated growth ring was originally just under the bark, then the determined date would represent the last year of the life of the tree before being felled. In this case, the barge could be constructed in AD 3 or 4. However, the appearance of the bottom plank does not allow us to determine either if the growth ring was, in fact, just under the bark or how many growth rings were removed during wood processing and barge construction. The date of AD 3 must therefore be considered as *terminus post quem*, as the year after which the tree was felled. To sum up, the results of radiometric and dendrochronological dating showed that the barge was probably constructed in the decade after AD 3.

The dendrochronological analysis and the selection of wood species suggest that local wood was used for the construction of the barge. Beech, silver fir and elm trees thrived in the forests of the Dinaric Karst in the hinterland of Vrhnika, which includes the southern fringes of the Ljubljansko barje. To the contrary, alder and ash thrived mostly on the floodplains of the Ljubljansko barje and the banks of the Ljubljana, similarly as today.

Among the domestic wood species, beech (*Fagus sylvatica*) is relatively high-density wood (the average density of absolutely dry wood  $r_0$  is 680kg/m<sup>3</sup>) with good mechanical properties. This means that the wood is solid and hard, but has a low durability, classified in the lowest wood durability class (5 – not durable).<sup>28</sup>

Beech wood is therefore not commonly used in ship and boat building, although it was occasionally used, primarily for small construction elements. Ships and boats built entirely of beech are exceedingly rare.<sup>29</sup> As mentioned above, the use of beech wood is primarily discouraged by its low durability, although water-saturated wood is generally safe against infection with insects and fungi.<sup>30</sup> In density and mechanical properties, beech wood is comparable to oak wood, while the latter has a resistant heartwood (resistance class 2 – durable).<sup>31</sup> The main domestic species of oak are sessile and pedunculate oak (*Quercus petraea* and *Quercus robur*) with a mean density of  $r_0$  650kg/m<sup>3</sup>.<sup>32</sup> Other wood species used in the construction have the following properties: ash (*Fraxinus*) – density 650kg/m<sup>3</sup>, durability class 5, elm (*Ulmus*) – density 640kg/m<sup>3</sup>, durability class 4, alder (*Alnus glutinosa*) – density 510kg/m<sup>3</sup>, durability class 5, and silver fir (*Abies alba*) – density 410kg/m<sup>3</sup>, durability class 4.<sup>33</sup>

Of these, silver fir is the only conifer. The woods of silver fir and alder have the lowest density and are less solid and hard than the wood of ash, elm and beech.

The facts presented above suggest that beech wood was most probably selected for barge construction because of its availability. One can also surmise that in Roman times, as today, the demand for oak was high and exceeded the supply. The quantity of oak wood was limited due to the low proportion of oak in surrounding forests. Because of its resistant heartwood, oak was used for various purposes, in particular for exposed constructions, as well as ships and boats.<sup>34</sup> In the case of the barge from Sinja Gorica, however, the readily available beech wood was chosen to build the heavy and robust vessel suitable for transporting heavy loads.

<sup>26</sup> Čufar 2010.

<sup>27</sup> Haneca, Čufar, Beeckman 2009.

<sup>28</sup> Lesar, Humar, Oven 2008; Čufar et al. 2012.

<sup>29</sup> Radić Rossi, Boetto 2011.

<sup>30</sup> Čufar et al. 2012.

<sup>31</sup> Humar et al. 2008.

<sup>32</sup> Merela, Čufar 2013.

<sup>33</sup> Gasser, Teetz 1987; Lesar, Humar, Oven 2008.

<sup>34</sup> Cf. Gaspari 1998a.

### Wood condition assessment

The condition of the wooden remains or their degradation was assessed by observation under a microscope and by determining the level of moisture content ( $MC_{max}$ ), which is based on the mass of water relative to the absolutely dry wood.<sup>35</sup>

The  $MC_{max}$  of the wood sample of the barge was 690%, which indicates highly degraded wood (Fig. 9). The English Heritage Guidelines on the recording, sampling, conservation and curation of waterlogged wood state that wood is very degraded when  $MC_{max}$  is above 150%.<sup>36</sup> For comparison,  $MC_{max}$  of normal beech wood is about 110%, of the beech wood from 4500-year-old pile dwellings in the Ljubljansko barje was around 800%<sup>37</sup> and of the beech wood from several construction elements of Roman ships found in the vicinity of Naples around 450%.<sup>38</sup>

Cell walls of the barge's wood fibres are about five times thinner than in normal wood, which is the result of long-term exposure to erosive bacteria.<sup>39</sup> Microscopic analysis also showed a decreased percentage of cellulose in cell walls and an increased percentage of lignin.<sup>40</sup>

The poor condition of the wood must be considered in the conservation plans for the vessel, particularly in view of the fact that the greatest danger for waterlogged wood is exposure to air and thus drying. Even during a very short exposure period, the wood shrinks and warps, hence the barge as a whole as well as individual construction elements would deform. In addition, partially dried wood also suffers biological degradation, which causes complete destruction of the remains in a very short time. The barge could be preserved by applying one of the commonly used consolidants,<sup>41</sup> but despite advances in waterlogged wood conservation, no known methodology can as yet assure long-term preservation of such heritage.<sup>42</sup> Moreover, the available methods are time consuming and expensive. Considering the importance of the find, on the one hand, and the reliability of the preservation

methods and their cost, on the other, preservation *in situ* thus seems to be the acceptable solution.

Čufar, Erič

### 5. BARGE CONSTRUCTION

Due to the described physical limitations, the wreck was only documented in the length of 4.2m. The exposed part of the vessel, which juts from under the sandy sediment of the river bank, shows that a part of it had already broken off at an earlier occasion. Since the last examination three years ago, the water flow has additionally damaged the remains and parts of two bottom planks (BP 2 and BP 3) have broken off. The recorded width of the barge is 2.47m at the end that broke off and 2.88m where it disappears under the sediment (Fig. 10).

#### Construction elements

The uncovered part of the barge is composed of two chine-girders, five bottom planks, one side plank, two floor-timbers and two side timbers (Fig. 10).

#### *Chine-girders*

**CG 1:** the chine-girder of beech wood shows degradation caused by the wreck's position within the riverbank, exposed to turbulent and erosive activities. It measures 3.3m in uncovered length, 31cm in width at the exposed end and 37cm in width in the part that continues into the riverbank, thus widening by a factor of 1.19. The height could not be measured because of the damage and only a small part at the transition from the bottom to the side part survives. It is 5cm thick at the contact with Bottom Plank 1, 10cm thick at the 45° angle of the knee and 8cm thick at the other end where it broke off. The chine-girder could be followed under the sediments for almost another 3m, increasing its recorded length to 6.3m. Along the contact with BP 1 in a width of 5–6cm, the wood of the chine-girder was of a brighter colour than elsewhere (Fig. 6: a, left; Fig. 10: C).

**CG 2:** the better preserved chine-girder, also of beech wood, measures 4.15m in uncovered length, 32cm in width at the exposed end and 38cm in width in the part that continues into the riverbank

<sup>35</sup> Čufar et al. 2008; Čufar, Merela, Erič 2014.

<sup>36</sup> Brunning, Watson 2010.

<sup>37</sup> Čufar, Tišler, Gorišek 2002.

<sup>38</sup> Capretti et al. 2008.

<sup>39</sup> Björdal Gjelstrup 2012; Singh 2012.

<sup>40</sup> Čufar, Merela, Erič 2014.

<sup>41</sup> The most widely used conservation procedures involve soaking in polyethylene glycol, melamine or sucrose.

<sup>42</sup> Cf. Christensen, Kutzke, Hansen 2012; Gregory, Jensen, Strætkvern 2012; Hocker, Almkvist, Sahlstedt 2012.

(widens by a factor of 1.18), as well as 34cm in height. It is 5cm thick at the contact with Bottom Plank 5, 9cm thick at the 92–94° angle of the knee and 6cm thick at the contact with Side Plank 1. The longitudinal curvature of CG 2 and SP 1, detectable in the 3D model as segment measuring 37m in diameter (*Fig. 25: a*), cannot positively be attributed to the work of the ship builders and can also be abrasion through river activity; the length of the curved part of the barge is relatively short and does not allow for certainty (*Fig. 6: a, right; Fig. 10: B*).

#### *Side and bottom planks*

Similarly as the chine-girders, all bottom planks and the side plank are broken off at the exposed end of the barge. None of the bottom planks show traces of working that would indicate possible joints with other bottom planks or internal construction with the exception of two floor-timbers. Also similarly as for the chine-girders, all planks (side and bottom) continue into the sediment of the river bank (*Fig. 6: a, right; Fig. 10: A, B*).

**SP 1:** a single side plank of beech wood has survived in the investigated part of the barge, in the length of 2.5m. It is 6cm thick at the contact with Chine-girder 2. It is heavily abraded and damaged particularly in the exposed part, while more of it survives towards the part that continues into the sediment, where it reaches the height of 30cm.

**BP 1:** the bottom plank of beech wood is broken off at the contact with Floor-timber 1. At this end, it is 50cm wide, while it is 54cm wide at the opposite side where it continues into the sediment. It measures 2.5m in uncovered length and 5–5.5cm in width. The wood on both sides of the plank (at the contact with CG 1 and BP 2), in width of 5 to 12cm, is of a brighter colour.

**BP 2:** upon discovery in 2008, the bottom plank of beech wood survived in the length of about 3m, while roughly 40cm of it has been abraded by the water flow in the years since then (the same holds true for BP 3), measuring in October 2012 only 2.55m in length. The recorded width in 2012 was 36cm at the exposed end and 37cm at the end that continued into the sediments, while the thickness was 5cm throughout. The wood is darker in the part along Floor-timber 1. Samples of this plank were taken for radiometric (*Fig. 8: AMS*) and dendrochronological dating (*Fig. 8: Sample 23*), with the results of the former show-

ing a date between 50 BC and AD 20 and of the latter a date of AD 3.

**BP 3:** the bottom plank of beech wood measured 2.4m in length (2.8m upon discovery), 35 and 38cm in width at either end, respectively, and 5cm in thickness. The wood is darker in the middle section, in the width of about 10cm.

**BP 4:** this beech wood bottom plank is the narrowest, measuring 16cm in width at the exposed end and 25cm at the opposite end. Its recorded length is 2.75m and thickness about 5cm. The wood has no darker areas.

**BP 5:** the longest surviving bottom plank of beech wood measured 2.85m in length, 39 to 41cm in width and 5cm in thickness. The wood has no darker areas.

All bottom planks taper slightly toward the sediment with an average factor of 1.06. This factor is much greater (1.56) for Bottom Plank 4.

#### *Floor-timbers*

Of the internal construction (knees, ribs, floor-timbers etc.), the barge only revealed two floor-timbers (*Figs. 8; 10; 11*) positioned 1.8m apart. The first floor-timber (**FT 1**) is made of a slim ash trunk with a diameter of 6.5–7.2cm and a length of 2.6m. The second timber (**FT 2**) is made of an elm trunk and measures 6.5–8cm in diameter and 2.77m in length. Both timbers are longitudinally cut in half and additionally thinned to a thickness of 3–4cm. They were inserted into the shell of chine-girders and bottom planks by being fitted with their flat sides down into 2.5cm deep grooves cut perpendicularly across the bottom planks and chine-girders. With the ends of a hexagonal cross section, they were inserted into square holes cut into the chine-girders and kept in place at each end with four wooden wedges (*Fig. 12: b*) driven from the exterior into the gaps so as to provide secure and watertight joints, the latter additionally assured by plant caulking (*Fig. 12: a*).

#### *Side timbers*

The documented partially surviving Side Timbers 1 and 2 are positioned at the only existing side (*Fig. 13*). The first timber (**ST 1**) measures 8.5 × 7cm in thickness and 31cm in height. The second timber (**ST 2**) measures 9 × 7cm in thick-

ness and 45cm in height. Both are rounded at the joint with the chine-girder (CG 2) and thus closely correspond with its curve (*Pl. 4: 1*, bottom). At the height of 11cm from the bottom, ST 1 is nailed to the side of the chine-girder (*Fig. 13: right arrow*). ST 2, which could not be preserved *in situ*, has a nail surviving at the height of about 39cm from the bottom (*Fig. 13: left arrow; Pl. 4: 2*); the nail probably served to attach the timber to the side plank (*Fig. 13: a; Pl. 4: a*), while the part where a nail of a similar function to that on ST 1 would be expected, is broken off in the height of 26cm.

### Caulking and joining

All seams between planks, chine-girders and floor-timbers were caulked with braided stems and leaves of grasses<sup>43</sup> (*Poaceae; Fig. 8: Sample 25; Fig. 14: a,b*) and beech-wood chips (*Fig. 8: Sample 21; Fig. 14: c,d,e*). Individual seams have an average width of 1.2–1.5cm, with the narrowest seam measuring 0.6cm and the widest 1.8cm, while the seam between BP 1 and BP 2 (*Fig. 14: e; see Fig. 8*) measures as much as 2.8cm on average (2.5–3.2cm) along the whole length.

The bottom and side planks are held together with iron clamps. They are made of an iron band and measure 3.9–10.3cm in length, 1.2–2.3cm in width and 0.2cm in thickness, while the bent ends are 0.8–2.8cm long (*Tab. 1*).

We documented 53 clamps on the uncovered part of the barge (*Fig. 15; List 1*), while three thin grooves indicate further clamps (*Fig. 15: g,h* [Nos. 52–54]). In 2008, we collected 15 scattered clamps in Grid Squares 36 and 37 (*Fig. 4; Pl. 1*) and in 2012 further 37 (*Fig. 16; Pls. 2; 3*), which adds up to a total of 105 recorded clamps.

The markedly varied dimensions of clamps suggest that the shipbuilders made the clamps on site. This is corroborated by most bent ends of the clamps not being pointed, but rather rounded or cut straight (*Pl. 2: 5,12,18*).

The interior clamps are positioned at an average interval of 32cm (more precisely from 17cm to 47cm) and bind the planks from both the interior and the exterior (*Fig. 15: a,b* [Nos. 41, 55, 56]).

The exterior clamps were positioned at similar intervals to the interior ones, as suggested by the distance between Clamps 55 and 56 (*Fig. 15*). The body of most was inserted into a groove previously cut into the wood (*Fig. 18*); such grooves on their own also indicate missing clamps (*Fig. 15: g,h* [Clamps 52–54]).

The variously sized clamps, but also Clamp 25 being driven only into CG 1 (*Fig. 15: e*) and Clamp 51 breaking off while being driven in (*Fig. 15: c*) indicate either a hasty or somewhat careless construction of the barge.

The floor-timbers are fastened to the chine-girders and bottom planks with iron nails (*Pl. 3; List 1*). The 2008 survey revealed two nails in Grid Square 37 (*Pl. 1: 16,17*) and investigation in October 2012 yielded additional two nails (*Fig. 19: a,b*; [PN 4, 6]; *Pl. 3: 17,18*). These nails measure 8.1–2.5cm in length, 0.5–0.8cm in shank thickness and 1.5–1.8cm in head diameter (*Tab. 1*). The nails were driven under a roughly 60° angle from alternate sides, through the floor-timbers into the bottom planks (*Fig. 20*). Six nails were driven into FT 1 and nine into FT 2 (*see Fig. 19*). Nails were also used to fasten the side timbers to the planking. During documentation, ST 1 was still firmly fastened to Chine-girder 2 (*Fig. 19: Nail 7*), while ST 2 was only pressed against the side of the barge by the surrounding sediment. This may be due to an intentional damage to ST 2, which was cut off in the lower half, in the height of 26cm, where it was attached to the chine-girder at the transition from the bottom to the side. The top part of this side timber still holds a part of a nail (*Fig. 19: PN 66; Pl. 4: 2*). The shape of the cut in this timber suggest intentional damage, so as to detach it from the side of the barge, because both timbers were otherwise worked to fit into the interior curve of the chine-girder.

### Wood working, traces of use and other

Our investigation also revealed features that were most probably not created during barge construction, but later, during the use of the vessel. The most obvious are two perforations, in SP 1 and CG 2, respectively. The former has a diameter of 10cm (*Fig. 21: b*) and is located almost in the axis of FT 2. A lack of conclusive evidence prevents us from determining its function with any certainty. The location of the wreck in the sediments and its exposure to the water flow through millennia

<sup>43</sup> We thank Tjaša Tolar from the *Inštitut za arheologijo ZRC SAZU*, Ljubljana, and Jernej Jogan from the *Katedra za botaniko in fiziologijo rastlin (Oddelek za biologijo, Biotehniška fakulteta Univerze v Ljubljani)*, Ljubljana. A more detailed analysis of the samples is still underway.

have led to heavy abrasive damage of the partially surviving west side plank, but we may nevertheless speculate that the plank was perforated during use (Fig. 22: **b**) and the hole possibly held a wooden bar that connected both sides (see Fig. 26). The hole appears similar to that on CG 2 positioned over FT 1 and beside ST 1. The diameter of that hole is 13cm (Figs. 21: **c**; 22: **c**).

The groove visible in BP 3, 4 and 5 (Fig. 21: **e**) runs across the barge in the same line as the hole in the side plank (Fig. 21: **a**), the possible continuation of this groove in BP 1 and 2 is not visible. The groove might represent the bedding of a partition. A hemispherical indentation was observed in FT 2 (Fig. 21: **d**), which might have served as bedding for a round object.

The wood of the barge, particularly of its side and bottom planks, is very degraded (see Fig. 9: **a,b**), also evidenced by the numerous cracks, the damage caused by a degrading cellular structure and consequently the “reshaping” and adjusting of the wood to the sediments (Figs. 21: **f**; 10: D,E). We could nevertheless observe that SP 1 has an indented edge (Fig. 21: **g**), though we cannot say whether this is an intentional groove or the result of water-flow abrasion; if it is intentional, it could have served as bedding for an additional wooden element between both sides of the barge.

The barge remains also included two small wooden boards, lying across CG 2 and BP 5, the function of which remains undetermined (Figs. 10; 23); we can even not be certain that they are connected with the barge.

This suggests a planned shape of each element and their pre-fabrication (see Fig. 10).

2. before joining the chine-girders and bottom planks, caulking of beech-wood chips and plant-fibre bundles was inserted in the seams. Individual elements may have been fastened with clamps from the interior already in this phase, though bottom planks and chine-girders may also have been held together by wedges stuck into stands at the outer edges of the barge bottom.

3. this was followed by cutting grooves for clamps across the interior joints between bottom planks, as well as grooves for floor-timbers into the bottom planks and chine-girders. The floor-timbers were probably inserted through one of the holes in the chine-girders and fastened to the bottom planks by nails driven into the wood under an angle, while the gaps between the holes in the chine-girders and the ends of the floor-timbers were caulked from the outside with plant fibre bundles in combination with small wooden wedges.

4. the next phase probably involved turning the bottom upside down so as to fasten the clamps from the exterior.

5. this was followed by adding the side timbers, which could have been executed simultaneously with the internal framework in other parts of the barge, by adding the upper side planks and making holes for the wooden bars.

6. in the end, if not before, clamps were attached across the interior joints of the hull and on the exterior of the sides.

*Erič*

**Shape**

## 6. CONSTRUCTION SEQUENCE AND SHAPE

### Construction sequence

Our investigation has led us to determine the construction sequence of the barge as follows:

1. the outline of the barge was determined by two symmetrically shaped chine-girders (CG 1 and CG 2) with a 1.19 and 1.18 factor of widening towards the middle of the vessel. The widening factor of the five parallel bottom planks (BP 1–5) is 1.06 and thus lower, with the exception of BP 4 that widens by a factor of 1.56. The joint between BP 2 and BP 3 runs along the central axis of the barge, so that one half of the bottom planking consists of two planks (BP 1 and BP 2) and the other half of three (BP 3–BP 5).

The shape of the barge from Sinja Gorica was compared with several flat-bottomed Roman boats from the northern Mediterranean hinterland and north-western Europe.<sup>44</sup> The curvature of the barge sides was revealed to correspond well with that of the barges from Lipe,<sup>45</sup> Bevaix, Yverdon-les-Bains 1<sup>46</sup> and Arles-Rhône 3<sup>47</sup> in roughly the first third of the vessel, while it is not comparable to that of

<sup>44</sup> The floor plans of selected boats were taken from the NAVIS I web page (<http://www2.rgzm.de/Na-vis/home/frames.htm>), with the exception of the Arles-Rhône 3 boat (<http://www.daily-motion.com/video/xl3bti-arles-rhone-3-de-la-fouille-a-la-restitution-du-chaland-gallo-romain-creation.UVMTWULfATM>) and the barge from Lipe (Gaspari 1998a).

<sup>45</sup> Gaspari 1998a.

<sup>46</sup> Arnold 1992.

<sup>47</sup> Djaoui, Greck, Marlier 2012.

the barges of the Rhineland group, which have a sharp curve in both the first and the last fifth, i.e. at the bow and the stern, and parallel sides in the middle three fifths (Fig. 24).

The comparison with the selected vessels from the northern Mediterranean hinterland (Fig. 25: a) also revealed that they have almost the same diameter of the side curvature at the same width (Fig. 25: b), with only the barge from Bevaix standing apart. The width of the stern and the bow depends on the length of the barge. However, whether these four (or even five including the barge from Sinja Gorica) vessels indicate the existence of a rule on that subject remains to be determined, with either a new find or a more detailed comparison.

Erič

## 7. COMPARATIVE ANALYSIS OF THE BARGE'S CONSTRUCTIONAL AND TECHNOLOGICAL CHARACTERISTICS AND ITS PLACE IN THE REGIONAL SHIPBUILDING PRACTICE

The 2012 fieldwork on the wreck and the results of the natural science research added to our knowledge of the barge and also, in part, changed previous conclusions.<sup>48</sup> With the barge still partially hidden under the sediments, however, even these results must remain partial and temporary.

The open shape with nearly vertical sides, the arrangement of the bottom and side planks, the caulking and other construction characteristics show a vessel of a size comparable with those of Roman cargo boats.

The shape and construction of the vessel reveal a longitudinal hull concept, which formed the basis of the Mediterranean shipbuilding tradition till the end of antiquity. This tradition involved first building the hull and then the internal framework. Within this tradition, the barge from Sinja Gorica falls into the group of flat-bottomed boats of bottom-based construction (*construction sur sole*).

The outline of the investigated part of the barge shows that the surviving section was probably located at one third of the whole length in relation to either the bow or the stern. The absence of more solid and densely arranged bottom framework (such as alternating solid timbers and ribs or pairs of solid timbers with knee-like side parts known

from similar cargo boats) and the groove on BP 3–BP 5 parallel to FT 2 (Fig. 21: e), which could indicate a removable partition, may be connected with easy loading and cargo storing. The stability of the sides against water pressure was ensured either by transverse bars (Figs. 21: b,c; 26), if the interpretation of the holes in the sides of the vessel is correct, or by some other temporary framework. In any case, the barge must have had additional frame elements, otherwise its sides could not resist the water pressure. The longitudinal strength of the planking is also questionable, as the widely-spaced floor-timbers in the uncovered part of the barge are only fastened with clamps and no additional method or element, such as wooden dowels (cloaks) or the mortise-and-tenon technique, was documented. The existence of a more solid framework is further suggested by the iron nails found outside their original positions, among them also a nail with a bent tip (Fig. 19: b [PN 4]; Pl. 3: 17).

The newly-found barge from Sinja Gorica importantly contributes to the knowledge of the regional practice of building Roman cargo boats of the inland type on the northern shores of the Adriatic Sea and its hinterland. Together with the roughly contemporary barge from Lipe,<sup>49</sup> which is about 30m long, 4.8m wide and has 0.60m high surviving sides, it ranks among the earliest known evidence of the range and capacity of river transport in the Roman times.<sup>50</sup>

The barge from Lipe, where the use of old wood caused some confusion in attempting to date the barge with the radiocarbon method, was built in the second half of the 1<sup>st</sup> century BC or the initial decades of the 1<sup>st</sup> century AD, according to the two youngest of the five analyzed samples.<sup>51</sup> It is considered a prototype of the so-called Romano-Celtic cargo boats that are between 18 and 40m long, up to 5m wide, and have a flat bottom, steep and 0.5–1.2m high sides, a sloping bow and stern, and made almost exclusively of oak wood. The roughly 30 such boats known in the area between southern France, lower Rhineland and the lower Danube region date between the Augustan period and the 3<sup>rd</sup> century AD and can be ascribed to at

<sup>49</sup> Gaspari 1998a; 1998b; 2009; Bockius 2000, 465–468.

<sup>50</sup> The earliest known remains of a flat-bottomed river boat are those of a sewn vessel from the 2nd century BC, found in 2008 at Motta di Cavanella d'Adige in Veneto, which the excavator ascribes to the Roman-Po tradition (Tiboni 2009).

<sup>51</sup> Gaspari, Erič 2012, 295, Pl. 1.

<sup>48</sup> Gaspari, Erič 2012.



least four regional shipbuilding traditions.<sup>52</sup> The applied technologies are predominantly Mediterranean in origin, but certain constructional features, such as moss caulking and the use of iron nails, can be traced back to the prehistory of both continental and Atlantic Europe. In the absence of Celtic-period prototypes of plank boats, the so-called Romano-Celtic boats are widely seen as a Roman answer to specific conditions of inland navigation and to a demand for increased capacity.

The Rhineland group of flat-bottomed barges mostly consists of boats of an octagonal outline with a long middle section with parallel vertical sides and sloping ends for easier loading and landing. A hydrodynamically more efficient ellipsoid outline with tapered ends is characteristic of the boats of the Rhône-Saône group and of several barges of the Alpine group from the lakes in west Switzerland. The documented width-to-length ratio, which is between 1: 5.7 and 1: 7.1, indicates a certain standardization of proportions. A metrologic design is also visible in the regularly spaced internal frame elements in some of the boats from this group, positioned every 59–60cm, which corresponds to the length of two Roman feet (1 *pes monetalis* = 29.6cm).

The construction of Romano-Celtic barges began by first determining the outline and dimensions of the bottom, followed by assembling bottom planks either in longitudinal strakes or in an irregular layout adapted to the available material. The transition from the bottom to the predominantly vertical sides was made with the aid of chine-girders, which held one or two side planks. These planks were assembled either edge to edge into carvel-built sides or with overlapping edges into clinker-built sides. Even before side planking, pairs of transverse timbers were laid into the floor with alternating knee-like transitions into vertical ribs reaching to the top of the sides. The framework could also be built using alternating transverse timbers and ribs. The framework was usually attached to the bottom planks with iron nails, at places also wooden dowels were used. The side planks were attached either before the ribs, using an auxiliary framework, or afterwards, in which case the side planks were attached to the ribs. For assembling the planking, the classic mortise-and-tenon technique was used in some boats and nails individually hammered under an angle in others. The planks were caulked with

moss, plant fibres or textile soaked in resin either before assembly or afterwards, by caulking the seams between the planks from the interior of the vessel. The caulking was sometimes kept in place with densely positioned iron nails or strips of textile, individually also with iron clamps.

The key technological feature distinguishing the barge from Lipe from other Roman river and lake boats from Europe north of the Alps is sewing, which was used to fasten individual planks after these were caulked with bundles of lime bast in the upper half of the seams (Fig. 27). The cylindrical groove made in the side edge of one of the planks is evidence of additional fastening with wooden tenons/dowels,<sup>53</sup> which made sewing during construction easier and at the same time prevented longitudinal movement of the planks. The use of either dowels or coaks, which resembles the presumably Phoenician technology of fastening planks using the mortise-and-tenon technique (*coagmenta puniciana*), represents a key element of fastening the planking in the seagoing vessels from the Greek cultural contexts [e.g. the Marseille Jules-Verne 9 ship (585–550 BC; Fig. 28), the Bon-Porté ship found near Saint-Tropez (530–525 BC), the Cala Sant Vicenç ship from the north-eastern shore of Mallorca (530–500 BC) and the Pabuç Burnu ship from the southwestern shore of Turkey near Bodrum (570–560 BC)],<sup>54</sup> where sewing replaced the pegging of the tenons of the joints of the presumably Phoenician technology, prevented the spreading of the seams and kept the caulking in place. In the later period of the sewing technique, the wooden dowels were mostly abandoned, possibly also in constructing the barge from Lipe, or only used in select parts of the planking, probably because the densely arranged frame elements provided the necessary longitudinal and transverse stability of the hull and the whole vessel.<sup>55</sup>

Continuous sewing, the earliest evidence of which in the Mediterranean may be provided by the ship from the Bay of Zambartija on the western coast of Istria, found in 2008 and dated to the beginning or the first half of the 1<sup>st</sup> millennium BC,<sup>56</sup> persisted longest in Dalmatia, in the northern Adriatic and the inland waters of its

<sup>52</sup> See Bockius 2000; Guyon, Rieth 2011; Holk 2011.

<sup>53</sup> Gaspari 1998b, 534, 541.

<sup>54</sup> Polzer 2009.

<sup>55</sup> Beltrame 2000, 93; Beltrame, Gaddi 2013, 299.

<sup>56</sup> Koncani Uhač, Uhač 2012.

hinterland.<sup>57</sup> Giulia Boetto and Corrine Rouse noted that the stitching pattern on the barge from Lipe is different and simpler than the cross (X type)-stitching of the seagoing-lagoon (e.g. Valle Ponti/Comacchio)<sup>58</sup> and river vessels (e.g. Stella at Precenicco)<sup>59</sup> of the so-called Romano-Po tradition, which is additionally marked by the use of the mortise-and-tenon technique in the upper parts of the hull, but also by the planking and the framework being fastened with wooden dowels and sewing. The two authors ascribed the barge from Lipe to the so-called Romano-Illyrian tradition, marked by zigzag and diagonal stitching and a predominant use of wooden dowels. Other ships of the latter tradition are those from Zambratija, all three ships from Zaton near Nin (1<sup>st</sup> century AD)<sup>60</sup> and the ship from the Caska Bay on the island of Pag (1<sup>st</sup>–2<sup>nd</sup> centuries AD).<sup>61</sup> The adjective Illyrian of this tradition implies a pre-Roman origin, substantiated by the Zambratija shipwreck, but also by literary sources mentioning sewing as a shipbuilding technique typical of the Istrians and Liburnians<sup>62</sup> (see *Tab. 2*).

In comparison with the barge from Lipe, the newly-found vessel from Sinja Gorica (*Fig. 10*) shows several technological differences, which, on the one hand, indicate the development of the regional building of cargo boats and, on the other hand, a hitherto **unknown type of framework in the form of slender floor-timbers** set into grooves cut into the bottom planks and protruding through the walls of the chine-girders. At this stage of research, however, it is not possible to determine either the exact shape of the floor-timbers' cross section (rectangular, trapezoid?) or to check the possibility of the timbers and corresponding grooves to taper slightly so as to provide additional stability of the joint.

The above-mentioned slender floor-timbers set into corresponding grooves, which may not have been used across the whole vessel and thus possibly combined with other framework elements, resemble the swallow-tail joint, an ancient carpentry technique known already in pre-metal periods of European prehistory. It is known on wheels dating

between the Neolithic and the Iron Age, where individual wheel boards were joined with two or more transverse laths of a trapezoid cross section; an example of this is also the Copper Age wheel from the area of the Stare gmajne pile-dwelling site near Verd in the Ljubljansko barje.<sup>63</sup>

In shipbuilding, a similar technological solution is known on vessels from the Bronze and Early Iron Ages of Atlantic Europe, namely on the Dover (roughly 1575–1520 BC), Ferriby 1 (roughly 1390–1130 BC) and Brigg boats (roughly 410–350 BC), where bottom planks are fastened either with continuous sewing or individual lashes, but also with transverse wedges inserted through holes in massive clots made of unhewn parts of the planks. This provided transverse stability of the bottom planking, but also the longitudinal and vertical alignment of the planks, which reduced shear between individual planks.<sup>64</sup>

The distance between the two documented floor-timbers of the barge from Sinja Gorica measures 1.78–1.82m. This corresponds to 6 Roman feet (1.78m) and indicates the use of metric rules. The timbers were attached to the planks with 8.1–12.5cm long **iron nails**, which were hammered at an angle from different directions and were similar in both shape and size to the nails used in the barge from Lipe.<sup>65</sup> The documented part of the vessel from Sinja Gorica did not allow us to determine whether these pierced through the boards or not. The former possibility is indicated by an 11.5cm long nail with a bent tip (see *Fig. 19: PN 6; Pl. 3: 18*), which was found lying on Floor-timber 1. We did not observe the use of wooden dowels, which distinguishes the barge from Sinja Gorica from those from Lipe and the Kolpa at Sisak (*Figs. 29; 30*), where the floor-timbers were fastened to the planking primarily or exclusively with dowels. On the barge from Lipe, iron nails were used only to attach the boards to the floor-timbers<sup>66</sup> and, according to Müllner's documentation, only a few of them reached through the planking, with their tips bent against the underside.<sup>67</sup> In contrast, the construction of the barges of the "Romano-Celtic" tradition from Gaul and Rhineland made extensive

<sup>57</sup> Beltrame 2000; Marlier 2002; Beltrame, Gaddi 2013, 300–303, Fig. 1.

<sup>58</sup> Berti 1990.

<sup>59</sup> Vitri et al. 2001; Fozzati, Capulli, Castro 2012.

<sup>60</sup> Brusić, Domjan 1985; Gluščević 2004.

<sup>61</sup> Radić Rossi, Boetto 2011.

<sup>62</sup> Boetto, Rouse 2011, 187–188, Fig. 9; ead. 2012.

<sup>63</sup> Velušček, Čufar, Zupančič 2009, 203–205.

<sup>64</sup> McGrail 2001, 184–191.

<sup>65</sup> Gaspari 1998a, 201, Fig. 21: 15–20.

<sup>66</sup> The traces of four nails in the ends of the surviving planking of the Aquileia-Canale Anfora 2005 vessel could indicate the spot where a rib/timber was attached to the planking (Beltrame, Gaddi 2013, 299).

<sup>67</sup> Gaspari 1998a, 202.

Tab. 2: Technological features of the group of sewn boats from the central and northern Adriatic and related boats from the regions in its hinterland.

Site (Age)	Operational environment	Hull shape		Plank fastening				Framework and hull fastening			Chine-girder	Material	
		Cross section	Water-line shape	Sewing pattern (spacing, in cm)	Dowels	Mortise-and-tenon	Clamps (Spacing)	Ropes /plaits/lashes	Tenons/Dowels	Nails		Hull	Framework (spacing, in cm)
<b>Zambratija</b> (first half of 1 <sup>st</sup> mill. BC)	sea	rounded	ellipsoid	diagonal (5)				+				<i>Ulmus</i> sp.	<i>Alnus</i> sp. (?)
<b>Caska</b> (1 <sup>st</sup> –2 <sup>nd</sup> c. AD)	sea	rounded	ellipsoid	diagonal (2–2.5)					+			<i>Fagus</i> sp.	<i>Quercus</i> sp. (39.5)
<b>Zaton 1</b> (1 <sup>st</sup> c. AD)	sea	rounded	ellipsoid	diagonal (2–2.5)					+				(33–45)
<b>Zaton 2</b> (1 <sup>st</sup> c. AD)	sea	rounded	ellipsoid	diagonal (2–2.5)					+				(13–20)
<b>Zaton 3</b> (1 <sup>st</sup> c. AD)	sea	rounded	ellipsoid	diagonal (2–2.5)					+				(32.7–41)
<b>Stella</b> (first half of 1 <sup>st</sup> c. AD)	sea - lagoon - river	rounded with flat bottom	ellipsoid	criss-cross (2.5)		+			+			<i>Ulmus</i> sp., <i>Quercus</i> sp.	<i>Quercus</i> sp. ? (ca 25)
<b>Valle Ponti- Comacchio</b> (Augustan period)	sea - lagoon - river	rounded with flat bottom	ellipsoid	criss-cross (2.5)		+		+	+			<i>Ulmus</i> sp.	<i>Quercus</i> sp. (45)
<b>Lipe</b> (End of 1 <sup>st</sup> c. BC–beginn. of 1 <sup>st</sup> c. AD)	river	flat bottom	ellipsoid	zigzag? (8–10)	+	17			+	+	C	<i>Picea</i> sp.	<i>Quercus</i> sp., <i>Ulmus</i> sp. (60)
<b>Sinja Gorica</b> (beginn. of 1 <sup>st</sup> c. AD)	river	flat bottom	ellipsoid				18–5			+	L	<i>Fagus</i> sp.	<i>Ulmus</i> sp., <i>Fagus</i> sp., <i>Abies</i> sp. (?)
<b>Sisak</b> (3 <sup>rd</sup> c. AD)	river	flat bottom	polygonal				7–10				L	<i>Quercus</i> sp.	<i>Quercus</i> sp. (55–60)

use of iron nails (*Fig. 31*), which were usually hammered from the interior through holes made in advance through the framework and the planking, and the protruding tips double-clenched into the wood.<sup>68</sup> On the boats from the Rhône-Saône group (Subgroup I), the bottom planks were hammered onto the elements of the framework both from the exterior and the interior, while in Subgroup II, where the mortise-and-tenon joints between bottom planks were used, they were fastened only from the interior.<sup>69</sup> An extensive use of iron nails is also attested to in a few Mediterranean ships from the Classical and Early Hellenistic periods, but was later completely replaced by fastening the framework to the planking with wooden dowels and only a few individual iron or bronze nails were used.<sup>70</sup>

A **chine-girder** hewn from a single piece of wood that provided a continuous transition from the bottom to the sides, the prevailing use of oak wood and the use iron nails to fasten the planking to the framework represent the distinctive features of the barges of the Romano-Celtic shipbuilding tradition. A more open design of the cargo boats with sides angled 20–35 degrees from the vertical axis, typical of shallow boats with carvel-built planking (e.g. Lipe, Lyon-Place Tolozan), dictated the use of chine-girders with a C-shaped cross section, while deeper barges with L-shaped chine-girders can either have carvel-built (Bevaix, Pommeroeul 2, Yverdon-les-Bains 1, Sisak, Sinja Gorica)<sup>71</sup> or clinker-built side planking above the chine-girder, the latter only appearing in the Rhineland group. In contrast, the transition from the bottom to the sides in the cargo boats of the Rhône-Saône group was made either with a half of a tree trunk fastened to the exterior plank and the ribs (Subgroup I) or with the lowest side plank fastened to the side edge of the outer bottom plank (Subgroup II).<sup>72</sup>

Another particular feature of the barge from Sinja Gorica are the numerous **iron clamps**, which joined individual planks at irregular intervals of 18–25cm in the vessel interior, while some clamps were also documented on the exterior of the bottom and the sides. At least in the interior, the clamps were set into prepared grooves, which

is a solution resembling that in sewn ships where the holes for ropes on the planking exterior had a semicircular, trapezoid or rectangular notch to house the rope.<sup>73</sup>

The only comparisons for joining planks and keeping the caulking in place with clamps are the boat from the shores of the Danube in the area of the fort of *Aquae* (Kušnjak, near Prahovo) in the Iron Gates<sup>74</sup> and a wreck of a barge in secondary use at the loading platform at the “Kovnica” site in the riverbed of the Kolpa at Sisak (*Fig. 29*).<sup>75</sup> The continental cargo boats from Gallic and German provinces did not reveal such use of clamps, though some Rhineland barges (e.g. Zwammerdam 2, Yverdon-les-Bains 1, Woerden 7) and two patrol ships from Oberstimm in the Bavarian section of the Danube (beginning of the 2<sup>nd</sup> century AD) revealed similar clamps used either to strengthen specific sections, used for small repairs or to keep in place the caulking usually inserted into seams after the planking had already been assembled.<sup>76</sup>

The boat from Kušnjak, roughly dated to the Trajanic period, revealed iron clamps at intervals of 5–10cm along the interior joints between the bottom and side planks, but in contrast to the barge from Sisak, their sequence is interrupted at places. In the barge from Sisak (*Figs. 29; 30*), presumably built around the mid-3<sup>rd</sup> century AD, clamps were used for the whole planking, placed either perpendicularly or slightly obliquely across the longitudinal and transverse joints of oak planks every 4–7cm. These, up to 5cm long clamps are very similar to those used in the barge from Sinja Gorica, where most clamps measure 3.9–6cm. Also similar is the plank size, which in the barge from Sisak measure 25–40cm in width and roughly 6cm in thickness, but also the caulking, which is made of plant material in both barges.

The barge from Sisak (*Fig. 29*), surviving as a roughly 7m long and 2.5m wide section of the bottom with one side still 1.1m high, shows a framework of solid oak timbers of rectangular cross section positioned every 55–60cm and separated by a pair of knee-like ribs of naturally bent wood. According to the notes by the head of the 1985 excavation (*Fig. 30*), the transition from the bottom to the nearly vertical side was executed with the chine-girders with an L-shaped cross section, the

<sup>68</sup> Bockius 2000, 453.

<sup>69</sup> Guyon, Rieth 2011, Fig. 4.

<sup>70</sup> Bockius 2000, 453.

<sup>71</sup> Bockius 2000, 471.

<sup>72</sup> Guyon, Rieth 2011, 98–99.

<sup>73</sup> Beltrame 2000, 93.

<sup>74</sup> Bockius 2001.

<sup>75</sup> Gaspari, Erič, Šmalcelj 2006.

<sup>76</sup> Bockius 2002b, 52–54; Holk 2011, 39.

inside of which was hewn into a circular shape and thus similarly as in the barge from Sinja Gorica.

In shape, construction features and the choice of wood, the barge from Sisak is close to the cargo boats from the Gallic and German provinces, though it is certainly a product of a regional tradition, with technical roots in the northern Adriatic and its hinterland. This conclusion is mainly based on the arrangement of the clamps, with the intervals similar to those between the holes in the edges of planks in sewn ships; this has been observed already by Ronald Bockius in his discussion on the boat from Kušjak, while in the barges from Sinja Gorica and Sisak this similarity is even more obvious.

Also typical of the Mediterranean practice is the exclusive use of wooden dowels for fastening the framework to the planking, the arrangement and the slanted scarfs between planks in longitudinal strakes, the alternating timbers and ribs, but even more so the triangular notches cut into the bottom side of timbers at places where they traverse plank joints. This feature, also observable in some of the barges of the Rhineland group (e.g. Zwammerdam 2, De Meern 1 and 4, Woerden 7),<sup>77</sup> has been interpreted as holes either for bilge water discharge, for ventilation or to slow down the decay of the ribs positioned over plank joints, though it more probably represents carpenter's marks, i.e. without a practical value and merely as a reminiscence of a technical necessity on sewn boats and ships where such holes held caulking material.<sup>78</sup>

The prevailing **wood species** used in the construction of the barge from Sinja Gorica is that of beech, which is surprising in view of the otherwise very rare use of beech wood in the antique and traditional shipbuilding in the Mediterranean.<sup>79</sup> Pliny the Elder does mention beech and walnut wood among the species suitable for underwater and underground construction, but explicitly states their poor durability (*N. h.* XVI 79). In modern carpentry, the properties of beech wood are similarly described and the durability of fresh beech wood in water is compared to that of larch wood.<sup>80</sup>

The planking of the seagoing ships of the ancient Mediterranean was commonly made of coniferous wood, in particular of various species of pine, cedar and fir, rarely spruce. The use of deciduous wood for the whole planking is thus a regional character-

istic, also appearing in several sewn ships. Beech wood was used for the planking of the 9m-long sewn ship from Caska,<sup>81</sup> while a more durable ash wood was used for the Zambratija ship and most of the Roman-period sewn vessels found along the coasts of Veneto and Friuli-Venezia Giulia (e.g. Stella, Aquileia-Canale Anfora, San Francesco del Deserto and Valle Ponti-Commachio).

The choice of beech wood for the barge from Sinja Gorica and the light spruce wood, which is difficult to work and not very durable in water, for the planking of the barge from Lipe, indicates the use of the tree species available locally in the vicinity of the Ljubljansko barje.

**Caulking** with beech or other plant material in the barge from Sinja Gorica is a constructional feature of a Mediterranean origin. In sewn ships from central and northern Dalmatia, caulking consisted of bundles of lime bast and vines (?), while sewing was done with ropes of flax and Spanish broom (*Spartium junceum L.*). The Rhineland group of Romano-Celtic barges is characterized by caulking of moss, grasses or wood fibres,<sup>82</sup> and the Rhône-Saône group by caulking of textiles soaked in resin.<sup>83</sup>

Of the flat-bottomed cargo boat, **the elliptic shape with more or less truncated ends** appears on the two barges from the Ljubljansko barje, but also several river or lake boats of the Rhône-Saône group and of the geographically neighbouring Alpine group. An almost identical curvature of the water line to those established for the barges from Lipe, Yverdon-les-Bains 1 and Arles-Rhône 3, is also presumed for the barge from Sinja Gorica; this indicates the existence of certain rules created with the aim of providing an optimal ratio between function (carrying capacity and type of cargo), navigability and manner of propulsion, but probably also with regard to the traditional elliptic-pointed shape of boats and ships with running planking of the Mediterranean shipbuilding tradition. This shape provided better navigability to the flat-bottomed cargo boats, which means higher possible speed and lesser propelling force, as well as better manoeuvrability in comparison to the angular boats of the Rhineland group (so-called *barques polygonales* of Type A3 after Béat Arnold).<sup>84</sup> A wide hull with a deep draught

<sup>77</sup> Bockius 2000, 455, 465, 468.

<sup>78</sup> See Bockius 2011, 54–55.

<sup>79</sup> Rival 1991, 64–66, 86, Tab. 4.

<sup>80</sup> Zalokar 1854, 302, 309.

<sup>81</sup> Radić Rossi, Boetto 2001, 509.

<sup>82</sup> Bockius 2002a, 208–213, Tab. 1–2.

<sup>83</sup> Guyon, Rieth 2011, 98–100.

<sup>84</sup> Arnold 1992, 73–74.

must understandably displace more water than a slender hull with a shallow draught, which slows down navigation. The latter is also slowed down by the total hydrodynamic resistance caused by the turbulent flow around the hull and the whirls appearing when the water runs towards the area of low pressure behind the stern; the pointed shape of the stern reduces this wake, at least underwater.<sup>85</sup>

Presuming that the water lines of the barges from Sinja Gorica and Lipe correspond, taking into account the **width-to-length ratio** of the barge from Lipe (roughly 1 : 6.4; length 28.7m; width 4.5m), which is close to that of the Zwammerdam 6 and Woerden 7 barges,<sup>86</sup> and considering the recorded width (2.47–2.88m) and height (0.65m) of the barge from Sinja Gorica, we can determine that the barge from Sinja Gorica was 20m long and 3m wide with roughly 0.7m high sides. The presumed size is comparable with the 2.8m wide Lyon/Parc Saint-Georges 2 and 8 boats, dated to AD 55 and 210–215, respectively, from the Rhône-Saône group,<sup>87</sup> which measured 18–25m in estimated length. Of the barges of the Rhineland group, the size corresponds with that of an almost 3m wide and 0.67m high barge from the Roman port on the Haine river in Pommeroeul (Belgium), which was dated to the second half of the 1<sup>st</sup> or the early 2<sup>nd</sup> century AD,<sup>88</sup> but also with that of the barge from the former meander of the Waal river near Druten (the Netherlands), dated to the end of the 2<sup>nd</sup> or the beginning of the 3<sup>rd</sup> century AD, of which the surviving segment was 16m long and 2.8m wide in the middle and 1.72m at the end.<sup>89</sup> However, individual completely surviving boats, such as Arles-Rhône 3 from the mid-1<sup>st</sup> century AD, nearly 3m wide and roughly 31m long (ratio 1: 10.5),<sup>90</sup> or the 24.7m long and 2.7m wide Vleuten-De Meern 1 cargo boat (ratio 1 : 9.1), built in AD 148, show that indexation can only be used as an indication in reconstructing the length of similar cargo boats.

The barge from Lipe probably never operated at its full theoretical **carrying capacity**, estimated at nearly 40 tons at 0.4m of draught.<sup>91</sup> Its **function** is indicated by the two parallel strakes of

floor boards, which presumably served to load wooden barrels. The most common barrels from contemporary contexts measure 1.9–2m in height, which corresponds to the width of the cargo space on the barge.<sup>92</sup> We can fairly safely exclude the possibility of the boat carrying bulk and rough cargo, because its loading or cleaning could damage the relatively thin (3.5–4cm) spruce planks and loosen the stitches. In the Arles-Rhône 3 and Woerden 1 barges, the central part was furnished with wood panelling attached to the floor-timbers and side-knees, which suggests that it was intended for sacks of foodstuffs or other goods that were not to come into contact with bilge water.<sup>93</sup> The arrangement of the investigated part of the barge from Sinja Gorica, which does not show any floor elements of the framework with the exception of a potential groove for a partition, could indicate that it was intended for lighter or less voluminous cargo, less susceptible to moisture (such as sand, clay, bricks etc.). However, it seems more probable that this part of the barge served as the cabin or cooking area separated from the rest of the vessel with a movable partition, similarly as on the Vleuten-De Meern 1 cargo boat.

*Gaspari*

## 8. CONCLUSION

The similar function and appearance of the two methods of joining planks and securing the caulking, but also the geographic proximity of the vessels from the Ljubljana near Sinja Gorica, the Kolpa at Sisak and the Danube at Kušjak suggest that the iron clamps represent a technological solution that began very early, in the Augustan period at the latest, to replace the demanding and time-consuming sewing, which was soon probably completely abandoned along the major rivers of the Black Sea catchment area. This shift was most likely brought about by the growing logistical demands of supplying the army, which is also indicated by the age of the barge from Sinja Gorica. Its contemporaneity with the barge from Lipe suggests that it is a product of shipbuilders who either mastered or were at least knowledgeable of both techniques, sewing and joining with clamps.

<sup>85</sup> For the physics of navigation see e.g. Anderson 2003.

<sup>86</sup> Holk 2011, 39.

<sup>87</sup> Guyon, Rieth 2011, 94.

<sup>88</sup> Boe 1978, 25–27.

<sup>89</sup> Lehmann 1990.

<sup>90</sup> Marlier 2011.

<sup>91</sup> Bockius 2000, Figs. 33 and 34.

<sup>92</sup> Gaspari 1998a, 215.

<sup>93</sup> Bockius 2000, 478.

The barge from Sisak, which most probably carried heavy and cumbersome loads, indicates that economic reasons caused the regional shipbuilding practice in the Imperial period to shift towards the construction of rigid cargo boats with an octagonal outline, with massive and less artfully crafted construction elements, as well as poorer navigational properties. Regardless of whether these capable vessels were used by the army, often managed by private contractors, or intended for public transportation, their construction was almost certainly in the domain of the military and executed by the amphibious units with qualified ship and boatbuilders (*fabri navales*) attached to the legions.<sup>94</sup>

## 9. CATALOGUE

(Pls. 1–4; List 1)

The Catalogue presents construction elements, namely clamps and nails. All are made of iron; hence the material is not especially stated for each object (with the exception of Side Timber 2 that is made of wood and together with the nail still in the timber represents the small find marked as PN 66 [Pl. 4]). Finds are kept in the Muzej in galerije mesta Ljubljane.

### Pl. 1:

– Small finds lying in the immediate vicinity of the boat, documented and collected in 2008. Marked with the grid square number and successive find number (e.g. 36–1).

### Pls. 2–4:

– Small finds lying on and around the boat, documented and collected in 2012. Marked with PN (special find) and successive find number (e.g. PN 1).

### List 1:

– Small finds fastened to the wooden remains of the boat, documented in 2012 and left *in situ*. Marked with S (clamp) and successive find number (e.g. S 34; see Fig. 15).

### Abbreviations:

No. on Pl. = Successive Number on Plate

L. = Length

W. = Width

Th. = Thickness

H. = Height

Surv. = Surviving (%)

FC = Field code

Head diam. = Head diameter

All measurements are given in centimetres.

## Acknowledgments

The research of the barge was headed by the *Center za konservatorstvo ZVKDS* (Conservation Centre of the Institute for the Protection of Cultural Heritage of Slovenia) and enabled by the *Ministrstvo za izobraževanje, znanost, kulturo in šport RS* and the *Agencija RS za raziskovalno dejavnost* (Lesarstvo / Wood technology P4-0015 and Računalniški vid / Computer vision P2-0214 research programmes, as well as J6-6348-0618, J6-4087 and L6-4157 research projects).

The research involved the collaboration of the members of the *Muzej in galerije mesta Ljubljane*, the *Univerza v Ljubljani* (*Laboratorij za računalniški vid Fakultete za računalništvo in informatiko*, *Oddelek za lesarstvo*, *Oddelek za mikrobiologijo*, *Katedra za botaniko in fiziologijo rastlin Oddelka za biologijo Biotehniške fakultete*), the *Inštitut za arheologijo ZRC SAZU*, Ljubljana, but also of Rok Kovačič (*Golden Light Photography Kult d. o. o.*), Gregor Berginc (*Xlab d. o. o.* and *3dimenzija d. o. o.*), Predrag Petrović and Luka Ritonja (*ArtRebel9 d. o. o.*), Tomaž Verbič (*Arhej d. o. o.*), Sašo Poglajen (*Harpha Sea d. o. o.*) and divers of CPA d. o. o.

Professional fieldwork help and support was provided by Luka Bekič, Anita Jelič (*Međunarodni centar za podvodnu arheologiju u Zadru*, Zadar) and Marko Uhač (*Direktorat za zaštitu kulturne baštine of Ministarstvo kulture Republike Hrvatske*), comments and discussion were offered by Ronald Bockius (*Museum für Antike Schifffahrt des Römisch-Deutsches Zentralmuseum*, Mainz), Giulia Boetto (*Centre Camille Jullian, Chargée de recherche au CNRS*, Aix-en-Provence) and Jana Horvat (*ZRC SAZU, Inštitut za arheologijo*, Ljubljana). Technical help with the illustrations was provided by Ida Murgelj (*Narodni muzej Slovenije*, Ljubljana), Janja Tratnik (*ZRS Univerza na Primorskem, Inštitut za dediščino Sredozemlja*, Koper) and Mateja Belak (*ZRC SAZU, Inštitut za arheologijo*, Ljubljana). We sincerely thank for all donations, particularly *Magelan Group* d. o. o. from Kranj, Municipality of Vrhnika, *Komunalno podjetje Vrhnika* d. o. o., *Avtotrade* d. o. o., *Gostilna Bajc* for providing accommodation, *Realprojekt* d. o. o., *Prostovoljno gasilsko društvo Bevke, Kamnolom Mivšek – Rajko Mivšek s. p.*, *Planinsko društvo Vrhnika*, *Cankarjeva knjižnica Vrhnika* and *Ribiška družina Vrhnika*.

Translation: Franc Solina

Erič

<sup>94</sup> Bockius 2000, 482–485.

Miran Erič  
Zavod za varstvo kulturne dediščine Slovenije  
Metelkova 6  
SI-1000 Ljubljana  
miran.eric@guest.arnes.si

Andrej Gaspari  
Ministrstvo za kulturo Republike Slovenije  
Maistrova 10  
SI-1000 Ljubljana  
andrej.gaspari@gmail.com

Katarina Čufar  
Oddelek za lesarstvo  
Biotehniška fakulteta  
Univerza v Ljubljani  
Rožna dolina Cesta VIII/34  
SI-1000 Ljubljana  
katarina.cufar@bf.uni-lj.si

Franc Solina  
Laboratorij za računalniški vid  
Fakulteta za računalništvo in informatiko  
Univerza v Ljubljani  
Večna pot 113  
SI-1000 Ljubljana  
franc.solina@fri.uni-lj.si

Tomaž Verbič  
Arhej d.o.o.  
Inštitut za geoarheologijo  
Drožanjska 23  
SI-8290 Sevnica  
tomazver@gmail.com



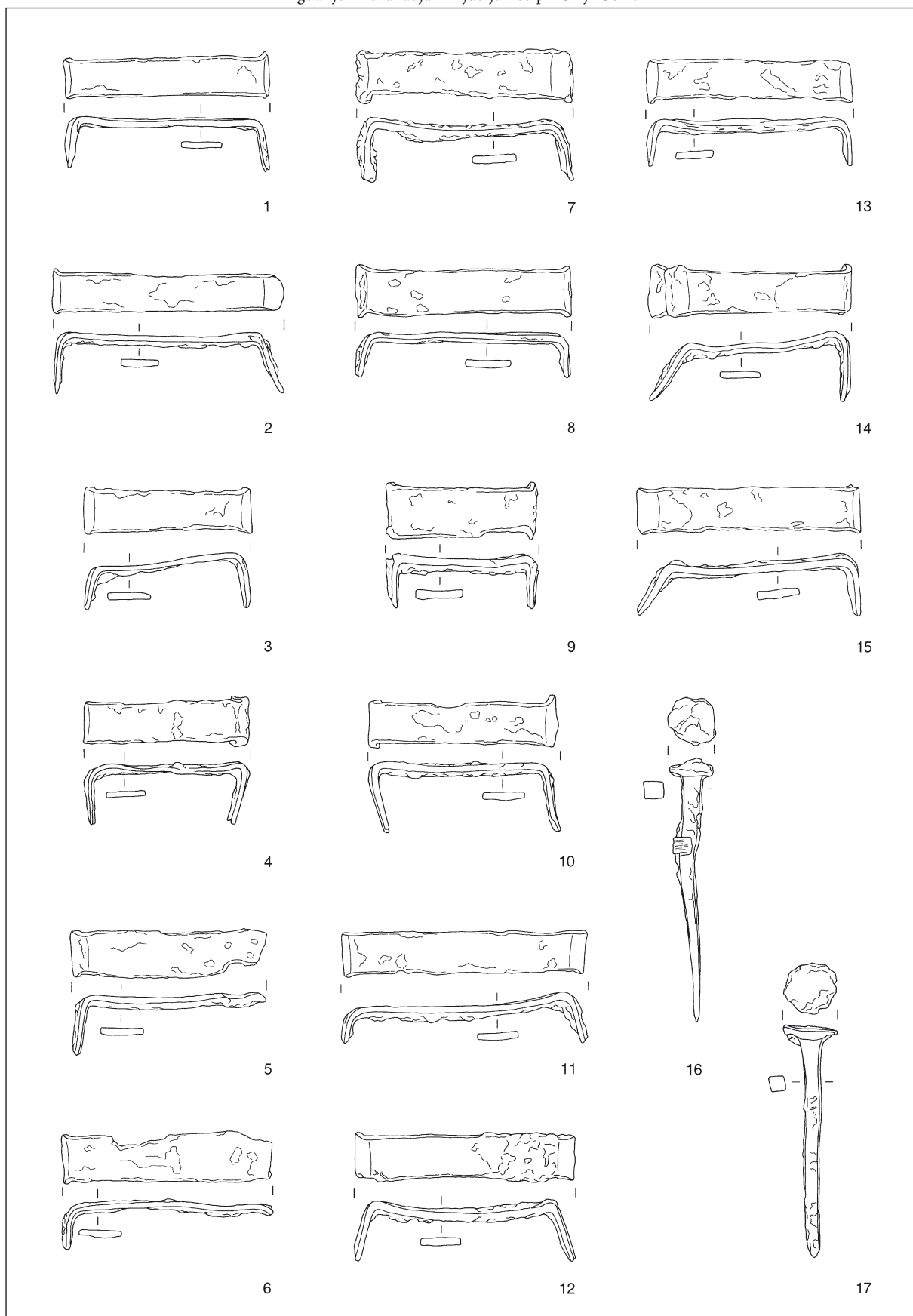

T 1: Ladja iz Ljubljane pri Sinji Gorici (leto 2008). Vse železo. M. = 1:2 (risba / drawing: J. Tratnik).  
 Pl. 1: Barge from the Ljubljana at Sinja Gorica (2008). All iron. Scale = 1:2.

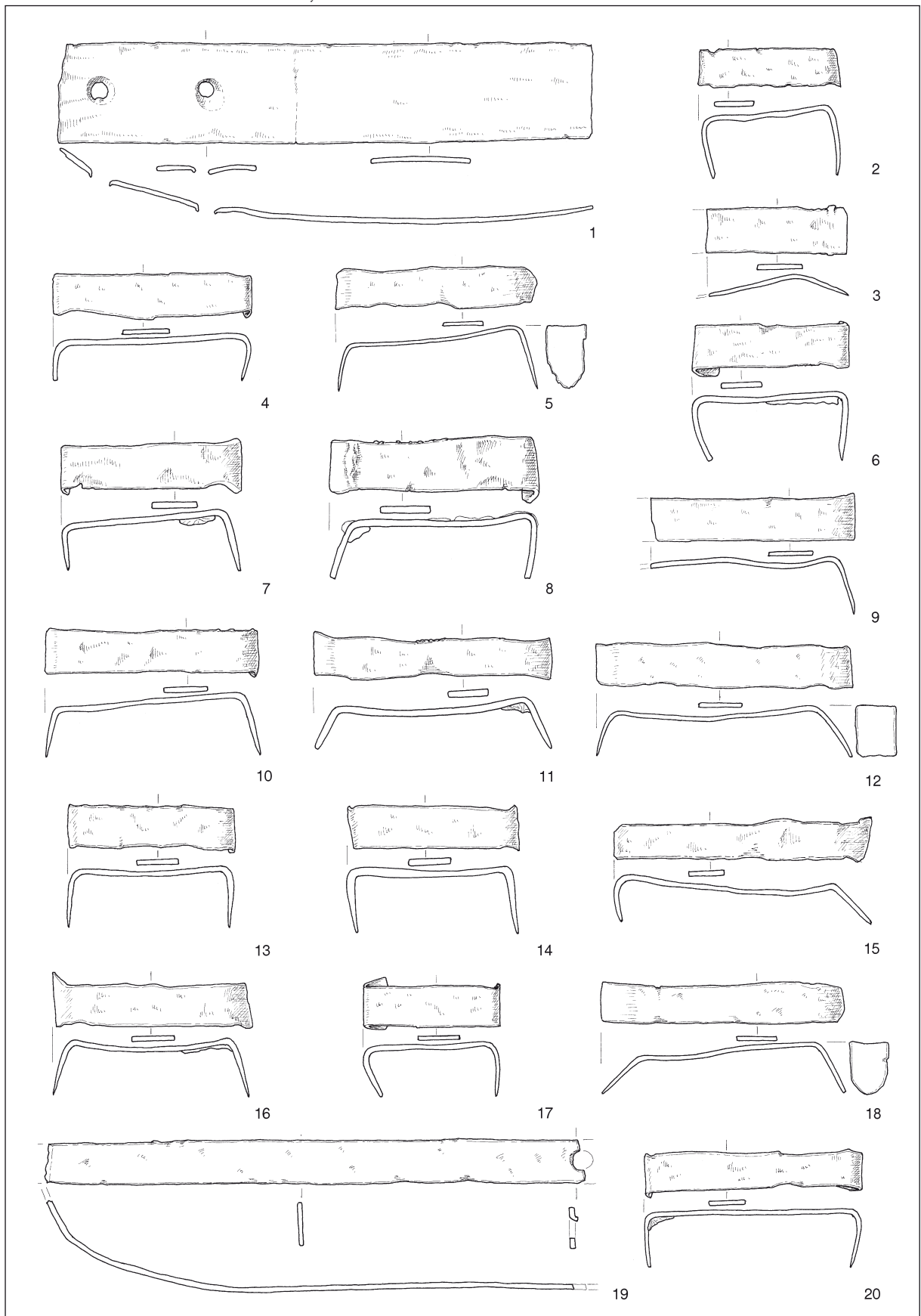

T 2: Ladja iz Ljubljance pri Sinji Gorici (leto 2012). Vse železo. M. = 1:2 (risba / drawing: I. Murgelj).  
 Pl. 2: Barge from the Ljubljana at Sinja Gorica (2012). All iron. Scale = 1:2.

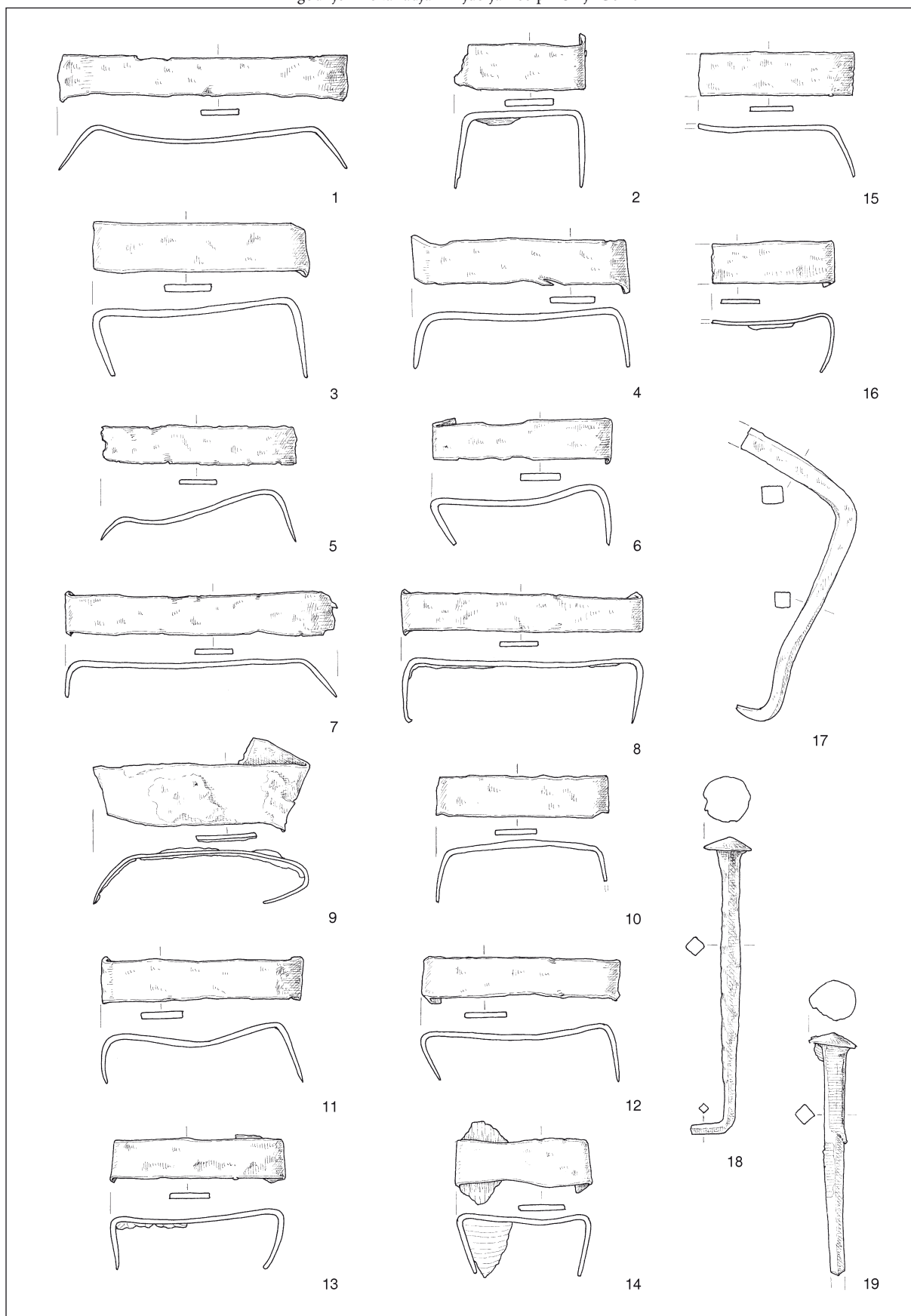

T 3: Ladja iz Ljubljane pri Sinji Gorici (leto 2012). Vse železo. M. = 1:2 (risba / drawing: I. Murgelj).  
 Pl. 3: Barge from the Ljubljana at Sinja Gorica (2012). All iron. Scale = 1:2.

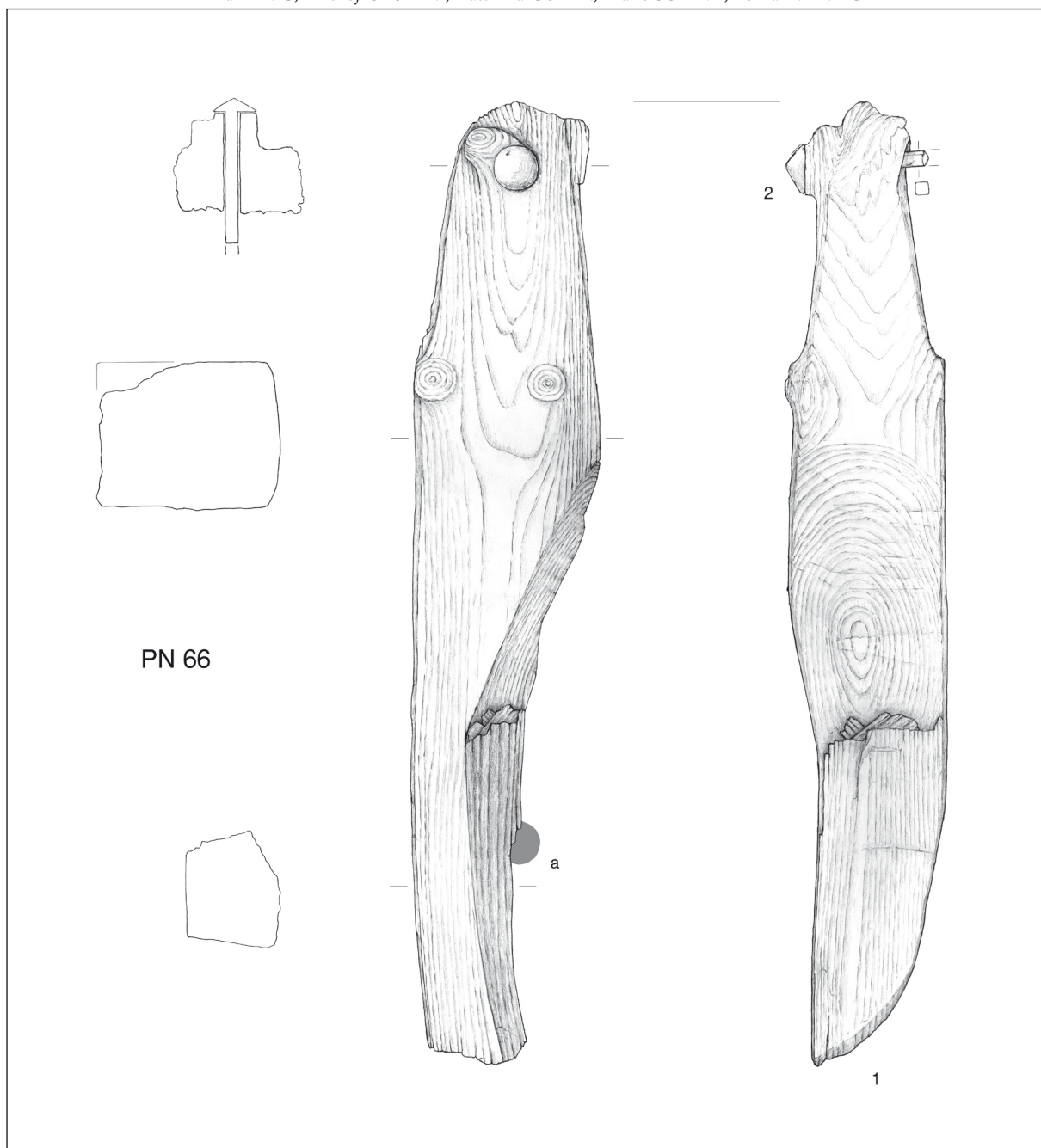

T. 4: Ladja iz Ljubljane pri Sinji Gorici (leto 2012). 1 – bočni tramič ST 2; 2 – žebelj; a – domnevno mesto žablja. 1 les; 2 železo. M. = 1:3 (risba / drawing: I. Murgelj).

Pl. 4: Barge from the Ljubljana at Sinja Gorica (2012). 1 – Side Timber 2; 2 – nail; a – presumed original position of the nail. 1 wood; 2 iron. Scale = 1:3.